

monoFab
SRM-20

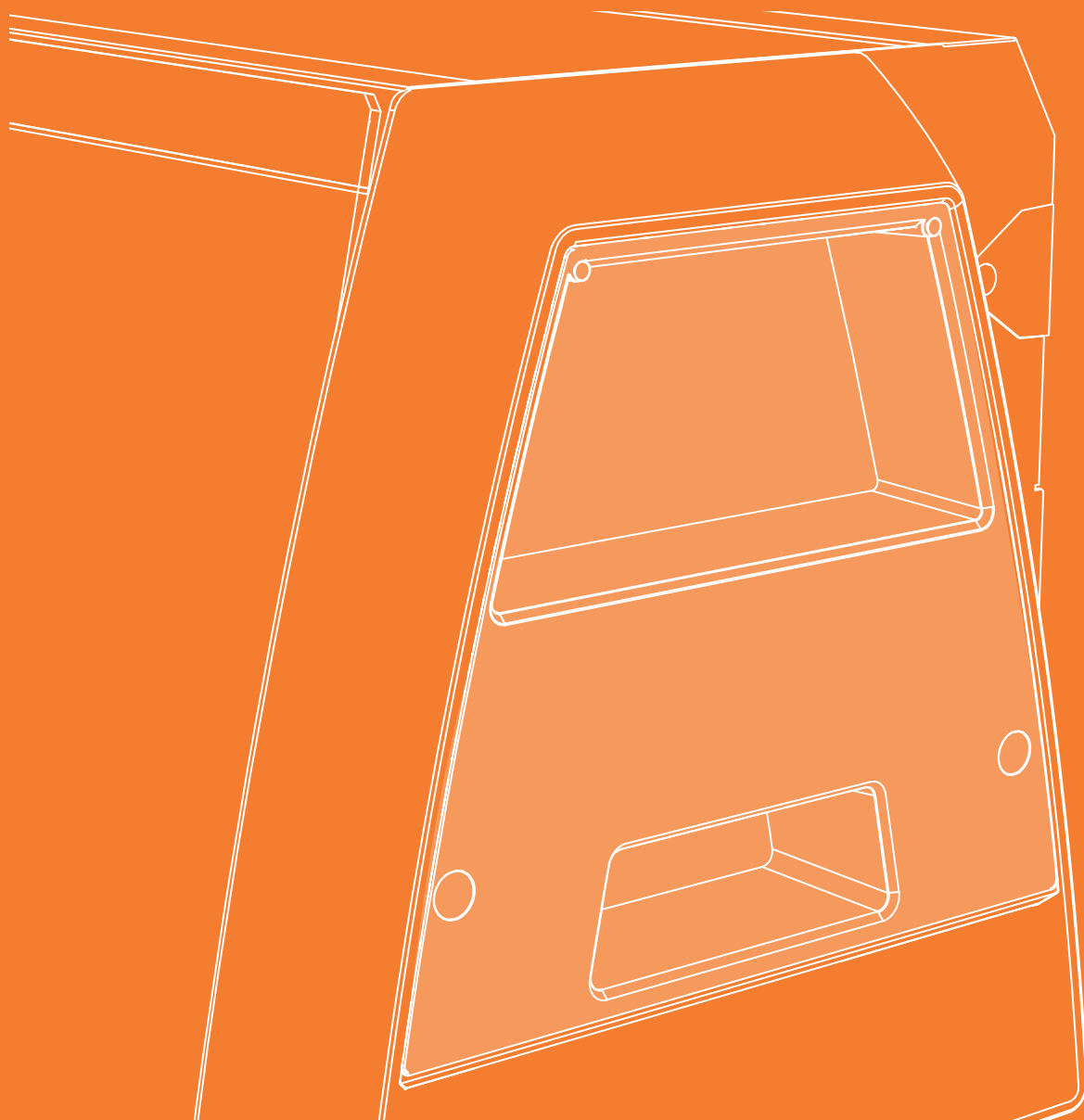

User's Manual

Basics

One Side Cutting 
Let's cut a piano (with included sample data)

NC Code

Maintenance

Getting Started

Thank you very much for purchasing this product.

- To ensure correct and safe usage with a full understanding of this product's performance, please be sure to read through this manual completely and store it in a safe location.
- Unauthorized copying or transferral, in whole or in part, of this manual is prohibited.
- The contents of this document and the specifications of this product are subject to change without notice.
- The documentation and the product have been prepared and tested as much as possible. If you find any misprint or error, please inform DGSHAPE Corporation.
- DGSHAPE Corporation assumes no responsibility for any direct or indirect loss or damage which may occur through use of this product, regardless of any failure to perform on the part of this product.
- DGSHAPE Corporation assumes no responsibility for any direct or indirect loss or damage which may occur with respect to any article made using this product.

<http://www.dgshape.com/>

Company names and product names are trademarks or registered trademarks of their respective holders.

Copyright © 2014 - 2017 Roland DG Corporation

Copyright © 2017 DGSHAPE Corporation

Contents

Getting Started	2	Scrap Boards	20
Contents	3	Cutting Area	21
Important Notes on Handling and Use	6	Maximum Cutting Area of SRM-20	21
Important Notes on Handling and Use	6	Actual Size That Can Be Cut	22
SRM-20 Basics	7	Z Cutting Range by Changing the Position of the Spindle Unit	23
The Feature of this Machine	8	One Side Cutting	24
Part Names and Functions	9	The Flow of One Side Cutting	25
Front	9	The Flow of One Side Cutting	25
Side	10	Items Necessary for Cutting	26
Back	10	Items to Prepare Yourself	28
VPanel (Operation Panel)	11	SRP Player	29
About VPanel	11	About SRP Player	29
Start VPanel	11	Starting SRP Player	30
The Name and Function of the Main Screen	13	Setting Up the Output Device	31
Setup Dialog	15	The Name and Function of the Tool bar	36
Cut Dialog	17	Display Help Dialog	37
Quit VPanel	18	Quit SRP Player	37
Cutting Tools	19	Creating an SRP Player File	38
Cutting Tool Types	19	Flow Diagram	38
Cutting Material / Scrap Boards	20	STEP 1: Determine the Size and Orientation of the Model ..	39
Material Types	20		

STEP 2: Determine What to Do	42	STEP 3 : Confirm the Command Set.....	83
STEP 3 : Create the Cutting Data.....	43	STEP 4 : Attach the Cutting Tool	84
STEP 4: Preview the Result of Cutting.....	46		
MODELA Player 4	47	Cutting (One Side Cutting).....	87
About MODELA Player 4	47	Flow Diagram	87
Starting MODELA Player 4	48	STEP 1 : Attach the Material to the Table	88
The Name and Function of the Tool bar.....	49	STEP 1 : Attach the Material to the Table	88
Display Help Dialog	50	STEP 2 : Set the Origin Point.....	89
Quit MODELA Player 4	50	STEP 3: Performing Cutting (when you are using SRP Player)	93
Creating a MODELA Player 4 File	51	STEP 3: Performing Cutting (when you are using MODELA Player 4).....	100
STEP 1: Load the Cutting Data.....	51	STEP 4 : Remove Processed Material	102
STEP 2 : Set the Machine Selection	53	STEP 5 : Turning the Power Off	103
STEP 3 : Set the Origin Point of the Model and Orientation .	54	Operations Available during Cutting	104
STEP 4 : Set the Material	57	NC Code	107
STEP 5 : Set the Margin.....	58	NC Code Setting	108
STEP 6 : Set the Surface leveling Process of Material.....	60	NC Code Setting Dialog.....	108
STEP 7 : Confirm the Cutting Preview.....	67	Test Cut Dialog in NC Code	110
STEP 8 : Set the Roughing Process.....	69	NC Code Specifications	111
STEP 9 : Set the Finishing Process.....	74	List of Settings Related to NC Code.....	111
Preparing the Machine	79	Items Related to the Mechanical Specifications	112
Flow Diagram	79	Interpretations of NC Code Omissions.....	113
STEP 1 : Turning the Power On	80	Word List.....	115
STEP 2 : The Machine Run-in	81		

Maintenance 117

Important Notes on Care and Maintenance 118

Cleaning after Cutting Operation Ends 119

Cleaning the X-/Z-Shafts 119

Replacement of the Consumable Parts 122

Caution and Note for Replacement of the Consumable Parts 122

Replacement Cycles and Replacement Methods of Consumable Parts 122

Confirm the Total Spindle Motor Rotation Time 123

Run in the Spindle 124

Replacement the Table 125

What to Do If..... 126

Initialization Is Not Performed / Initialization Fails..... 126

VPanel Does Not Recognize the Machine 126

Operations Are Ignored..... 127

The Spindle Doesn't Rotate / Spindle Rotation Speed Is Wrong 128

The Feed Rate is Wrong 128

Abnormal Cutting is Performed 129

The Origin is Misaligned 129

The Cutting Results are Not Attractive 130

It Takes Time to Delete Data After Quitting Cutting..... 130

The Cutting Tool Rises at an Unintended Point in the Course

of Cutting 130

The Power Turns Off After Cutting Ends..... 131

The Cutting Tool Does Not Reach the Material 131

The Driver Cannot Be Installed 131

Uninstalling the Driver..... 133

Abnormal Noise Occurs..... 135

Changing the Position of a Spindle Unit 138

Initializing This Machine's Settings 141

Displaying This Machine's Settings 142

Confirm the Version Information 143

Sample files are not found 143

Responding to Error Messages..... 144

Message is Displayed 144

Appendix 146

Specifications 147

External View..... 147

Main Specifications..... 151

Important Notes on Handling and Use

Important Notes on Handling and Use

To ensure the full performance of this machine, be sure to observe the following important points. Failure to observe these may not only result in loss of performance, but may also cause malfunction or breakdown.

This machine is a precision device.

- Handle carefully, and never subject the machine to impact or excessive force.
- Diligently keep clean of cutting waste.
- Use within the range of specifications.
- Never attempt to move the spindle head and table by hand with undue force.
- Never needlessly touch anywhere inside the machine except for locations specified in this manual.

Install in a suitable location.

☞ Roland DG Start-up "<http://startup.rolanddg.com>"

This machine becomes hot.

- Never cover the ventilation holes with cloth, tape, or anything else.
- Install in a well-ventilated location.

About Cutting tools

- Use a cutting tool that is suitable for the material and the cutting method.
- The tip of the cutting tool is breakable. Handle with care, being careful not to drop it.

Never allow children to use this machine by themselves and keep it out of children's reach

- Never keep the machine within children's reach to prevent them from inadvertently swallowing a small part, etc.
- Restrain children from playing with the plastic bag used for packing. Pulling the plastic bag over one's head or swallowing it may lead to suffocation.

DGSHAPE Corporation has licensed the MMP technology from the TPL Group.Part Names

SRM-20 Basics

Important Notes on Handling and Use	6	Cutting Area	21
Important Notes on Handling and Use	6	Maximum Cutting Area of SRM-20.....	21
The Feature of this Machine	8	Actual Size That Can Be Cut	22
Part Names and Functions.	9	Z Cutting Range by Changing the Position of the Spindle Unit	23
Front	9		
Side.....	10		
Back.....	10		
VPanel (Operation Panel)	11		
About VPanel	11		
Start VPanel	11		
The Name and Function of the Main Screen	13		
Setup Dialog	15		
Cut Dialog.....	17		
Quit VPanel.....	18		
Cutting Tools	19		
Cutting Tool Types	19		
Cutting Material / Scrap Boards	20		
Material Types.....	20		
Scrap Boards	20		

The Feature of this Machine

"SRM-20" Advanced cutting techniques that support a variety of materials

This machine is capable of cutting a wide variety of materials including chemical wood, acrylic, and ABS. It is also capable of a range of accuracy settings from prototype to product design. Plus its small size and fully covered design allows you to enjoy cutting more safely and with peace of mind.



"VPanel" Easily operated software

Operation of this machine is performed on the screen of a computer using [VPanel]. Beginners can operate the machine easily.

☞ "VPanel (Operation Panel)" (p. 11)



A full array of software included

Exclusive CAM software is included so that you can start cutting immediately after creating cutting data. Cutting software is also included to meet various usages.

☞ Download "<http://startup.rolanddg.com>"



Part Names and Functions

Front

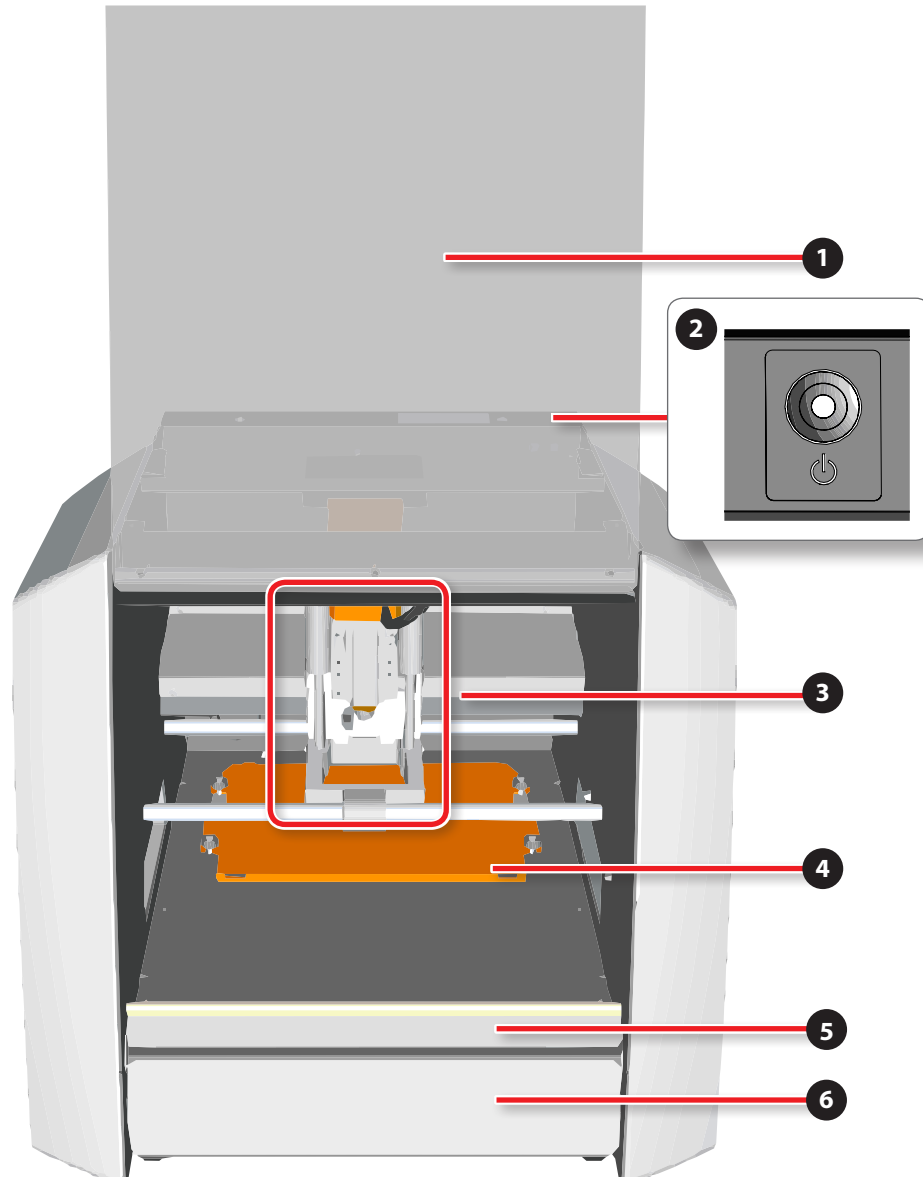

1	Front cover
2	[⏻] (Power) button
3	Spindle head ⚠ CAUTION Under no circumstances move the spindle unit or table with your hands. Doing so may cause a breakdown. <ul style="list-style-type: none">In this manual, the mechanisms around the spindle unit, including the spindle motor, are called the "spindle head." Also, the rotary-axis area inside the spindle unit is called the "spindle."
4	Table
5	Front guard
6	Dust tray

Side

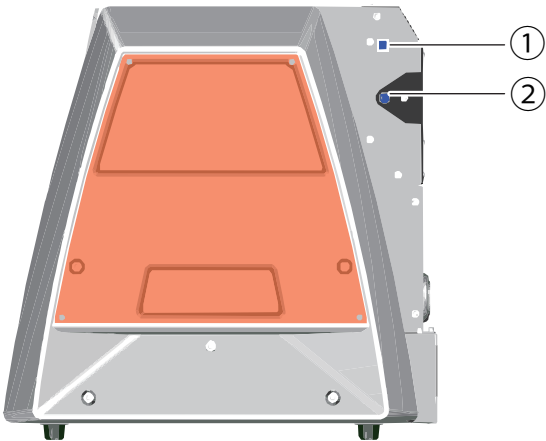

1	USB connector
2	Power connector

Back

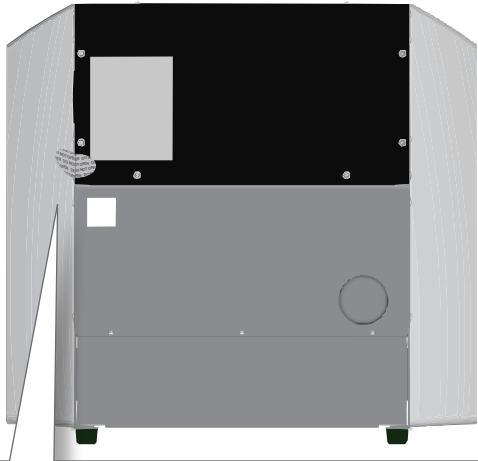

Security label

You will void the machine's warranty if the security label is removed.



VPanel (Operation Panel)

About VPanel

It is the dedicated software for controlling this machine. Operation of this machine and various setup are performed using this software.

Download "<http://startup.rolanddg.com>"



Start VPanel

Procedure

1. Close the front cover.
2. Press the [ON] (Power) button.
The LED lamp starts flashing and it stays lit after initialization completes.

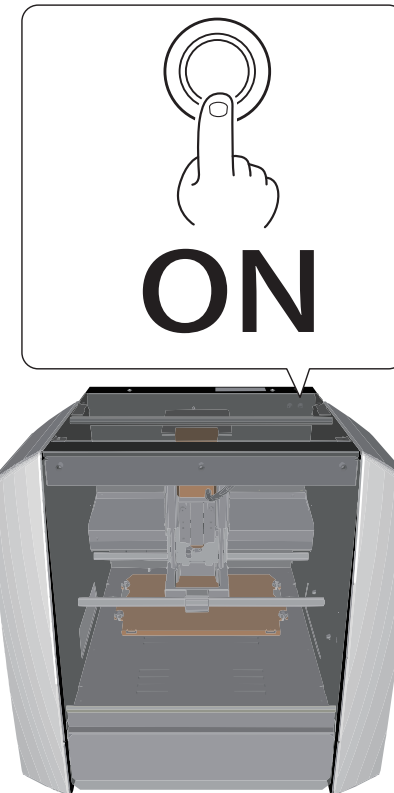

3. Start "VPanel."

☞ "VPanel Does Not Recognize the Machine" (p. 126)

MEMO

If VPanel is started with the machine's power turned off, the following screen is displayed. Press the [⏻] (power) button and click [Retry] to start VPanel.

Windows 8.1

1. Click  in the "START" screen.
2. Click [VPanel for SRM-20] in the [APPS] screen.

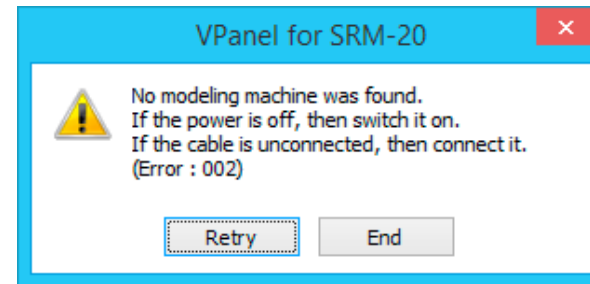
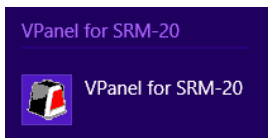

Windows 8

1. Right - click in the "START" screen.
2. Click  .
3. Click [VPanel for SRM-20] icon of [VPanel for SRM-20].

Windows 7

1. Click  "START" menu.
2. Click [All Programs] (or [Program]) - [VPanel for SRM-20] - [VPanel for SRM-20].

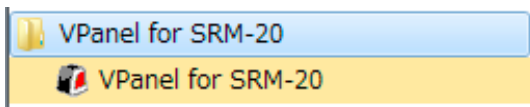

The Name and Function of the Main Screen



No.	Name	Function	No.	Name	Function
1	Coordinate system	<p>Selects the coordinate system for the coordinate values to display.</p> <ul style="list-style-type: none"> User Coordinate System : A coordinate system in which the location of the origin point can be freely changed Machine Coordinate System : A machine-specific coordinate system in which the location of the origin point is fixed G54 - 59 : A workpiece coordinate system in NC code EXOFS : A coordinate system used with NC code <p>☞ "NC Code" (p. 107)</p> <p>☞ Separate volume "NC Code Reference Manual"</p>	4	Spindle	<p>In [ON] and [OFF], rotation of a spindle is started and it stops.</p> <p>The number of rotations of the spindle under operation is displayed.</p>
2	Coordinates	<p>The current position of a cutting tool is displayed. The change of mm<=>inch can be performed.</p> <p>☞ "Unit" (p. 15)</p>	5	Feed buttons	<p>Clicking these buttons moves the spindle head or table. Holding down the buttons performs continuous movement.</p> <p>☞ "Direction of Y axis using keypad" (p. 15)</p>
3	Speed	<p>The movement speed of a cutting tool is displayed.</p>	6	Cursor step	<p>Specify how much the cutting tool should move every time you single-click the [X]/[Y]/[Z] button.</p>

No.	Name	Function	No.	Name	Function		
7	Move	View					
		XY / Z					
		Stop					
8	Set Origin Point	Select the coordinate system for setting the origin point. ☞ "STEP 2 : Set the Origin Point" (p. 89)	12				
9	X/Y / Z	Sets the current XY position to the base point. Sets the current Z position to the base point.				Set up	Sets the cutting machine's operating conditions and the correction values for the axes. ☞ "Setup Dialog" (p. 15)
10	Adjust	The feeding speed of a cutting tool is adjusted. ☞ "Adjusting Cutting Speed (Override)" (p. 106)				Cut	Configures cutting settings. ☞ "Cut Dialog" (p. 17)
			Pause	Pauses and resumes cutting. ☞ "Pausing / Resuming" (p. 104)			
				Cancel	Cancels cutting.		

Setup Dialog

This dialog is displayed when  setup is clicked.

Modeling Machine Tab

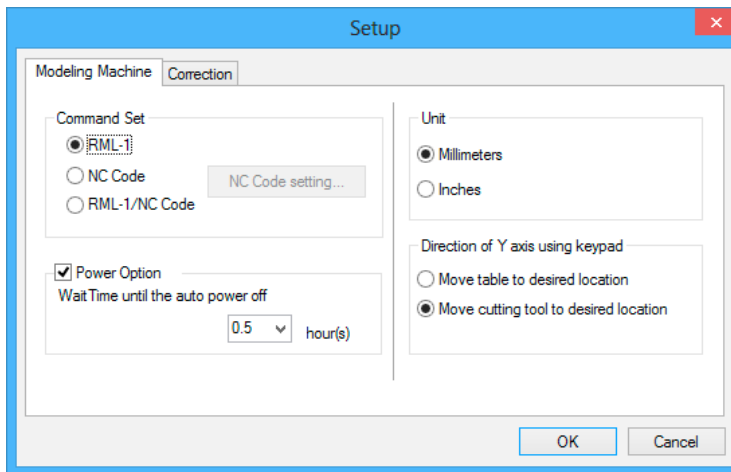

Display	Function
Command Set	<p>Select the appropriate command mode to match the software to be used.</p> <ul style="list-style-type: none"> • [RML-1] : Select this command set when you want to use the software that was included with this machine • [NC Code] : Select this command set when you want to use NC codes ↳ "NC Code Specifications" (p. 111) • [RML-1/NC Code] : Select this option to enable the machine to receive cutting programs that use the RML-1 or NC code command sets ↳ "STEP 3 : Confirm the Command Set" (p. 83) <p>Initial setting : "RML-1"</p>
Power Option	<p>The machine's power can be automatically turned off (auto-power-off function). You can disable auto power-off or enable it so that the power is automatically turned off in 0.5 to 24 hours.</p> <p>Initial setting : "0.5 hours"</p>
Unit	<p>The display of the unit of a coordinate system can be chosen. (For the inches display, the millimeters value is converted and displayed.)</p> <p>Initial setting : "Millimeters"</p>
Direction of Y axis using keypad	<p>The movement direction when the Y-axis feed button is pressed can be set. Under the factory default settings, Y-axis movement assumes a direction of cutting tool movement relative to the object being cut. This means that clicking a Y-axis feed button makes the table move in the opposite direction from what the arrow indicates.</p> <p>Initial setting : "Move cutting tool to desired location"</p>

Correction Tab

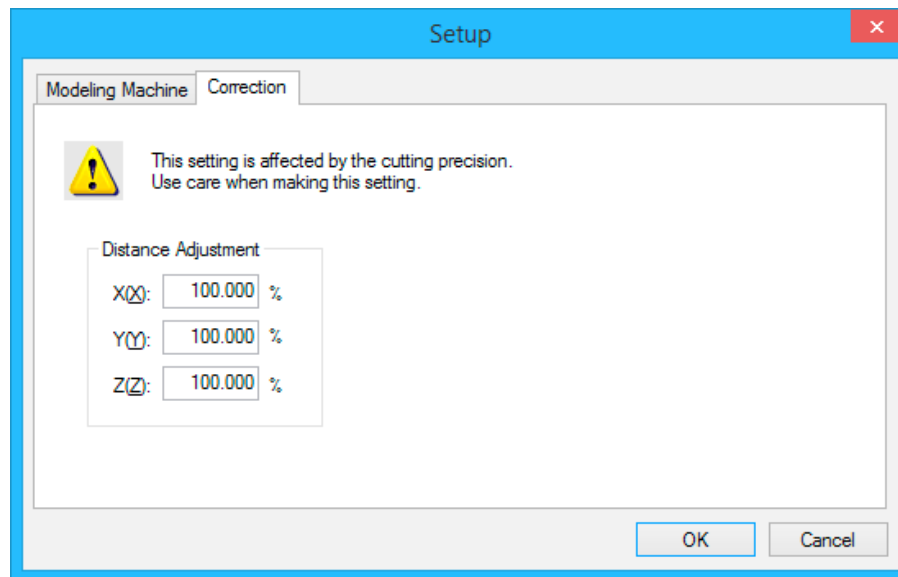

Display	Function
Distance Adjustment	The distance correction for the X-, Y-, and Z-axis can be set. Distance Adjustment : 99.5~100.5

NOTICE

This setting affects the cutting accuracy. Exercise care when you specify this setting. If you are not confident in the value that you want to specify, we recommend that you do not specify this setting.

Cut Dialog

This dialog is displayed when cut  is clicked.

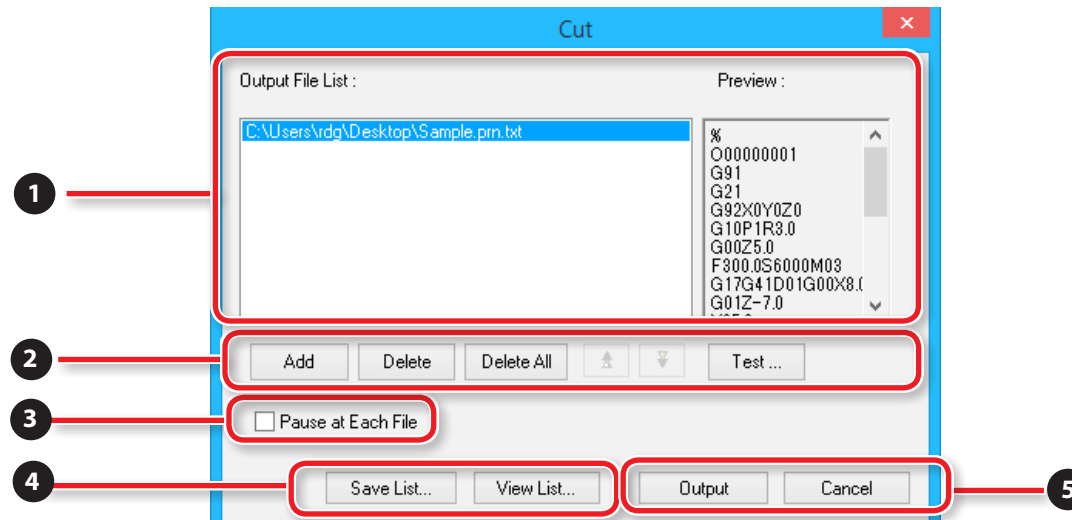

No	Display	Function
1	Output File List	Output files are listed in the order they are output.
	Preview	You can preview the selected file.
2	Add	Adds the file to output to the [Output File List] .
	Delete	Deletes the selected file from [Output File List] .
	Delete All	Deletes all file from [Output File List] .
		Moves the output order for the file in [Output File List] once forward or backward.
	Test	If a cutting data file is written in NC code, you can test the output of the file to check for the presence of mistakes (bugs). ☞ "Test Cut Dialog in NC Code" (p. 110)
3	Pause at Each File	Select this check box to pause output after a single file is output.
4	Save List	The output file list and output order can be saved to a file.
	View List	Opens a file saved with [Save List] .
5	Output	Outputs the files in the output file list to the cutting machine in order from the top. The dialog closes once the output begins.
	Cancel	[Cut] edit of the file carried out in the dialog is canceled and a dialog is closed.

Quit VPanel

Click  .



Cutting Tools

Cutting Tool Types

The SRM-20 supports the use of cutting tools with a shank diameter of up to 6 mm.

* An optional collet is required when the shank diameter is 3 mm or 4 mm.

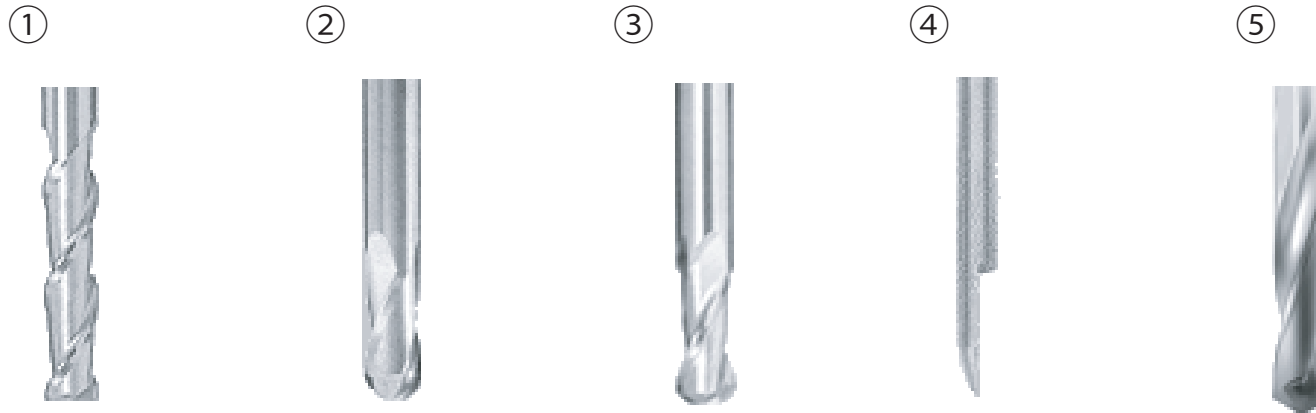

No.	Name	Shape	Appropriate cutting method	Remarks
①	Straight (square)	Flat tip	Surface leveling Roughing	Suited to cutting flat surfaces
②	Ball	Round tip	Finishing	To cleanly finish the cut surface
③	Radius	Flat tip with round corners	Roughing	Lines do not easily occur after the cutting tool has passed by Less remaining cutting waste when compared to the ball
④	Conical	Pointed tip	Engraving	The groove width (character thickness) changes according to the cutting depth
⑤	Drill	Tip with blades	Drilling	Drill diameter = hole diameter

Cutting Material / Scrap Boards

Material Types

There are various kinds of the charges of a cutting material. Please use material properly by work what you want to cut.

Chemical wood

A material made of resin powder that has been hardened with an adhesive. It is available in various types by specific gravity. Compared to other materials, it is soft and easy to cut, but the thinner it is, the more easily it will break.

Sanmodur

One type of chemical wood that is light and suitable as a material for creating models and molds. Sanmodur is a registered trademark of Sanyo Chemical Industries, Ltd.

ABS

This material takes longer to cut than chemical wood, but it is suitable when you want to thinly finish details.

Modeling wax

This material is suitable for creating figures and for creating prototypes of jewelry because it is soft and excellent for fine cutting by small diameter cutting tools.

Scrap Boards

A scrap board is a board that is placed under the material when cutting it so that the table is not cut. It is used as a temporary, subsidiary material when cutting out the material.

Cutting that requires a scrap board (the procedure for using a scrap board is detailed in the “Double-sided Cutting Manual.”)

A scrap board is required for cutting that will cut out (pass through) the cutting material. Match the thickness of the scrap board to the depth of the cut-out. If you do not have a scrap board with a sufficient thickness, there is a risk of not only cutting the table, which will damage or scratch it, but also of breaking the cutting tool.

Cutting Area

Maximum Cutting Area of SRM-20

CAUTION

Arrange the material, Jig, and the like so that they fit within the determined range. Anything extending beyond may strike moving parts. Be sure to observe this requirement, as failure to do so may result in damage to the workpiece or frame or malfunction of the machine.

XY Direction

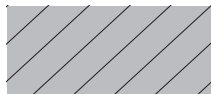

... Maximum Cutting Area

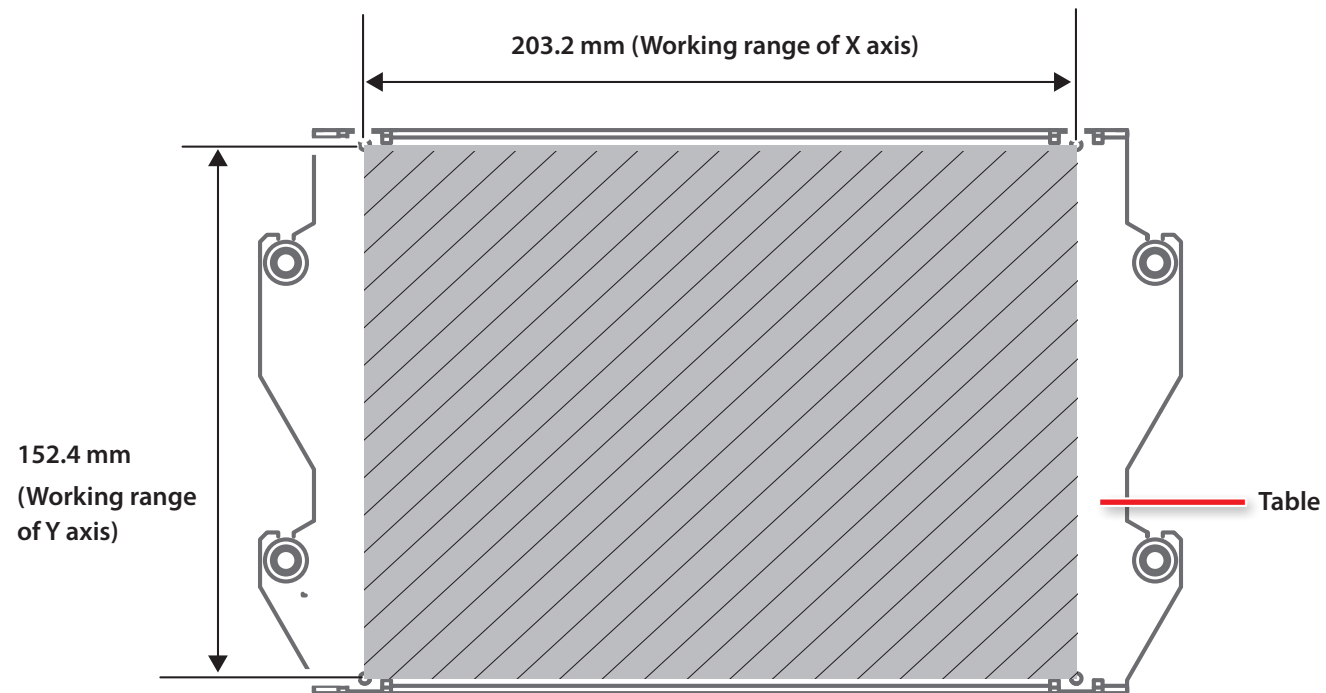

Z Direction

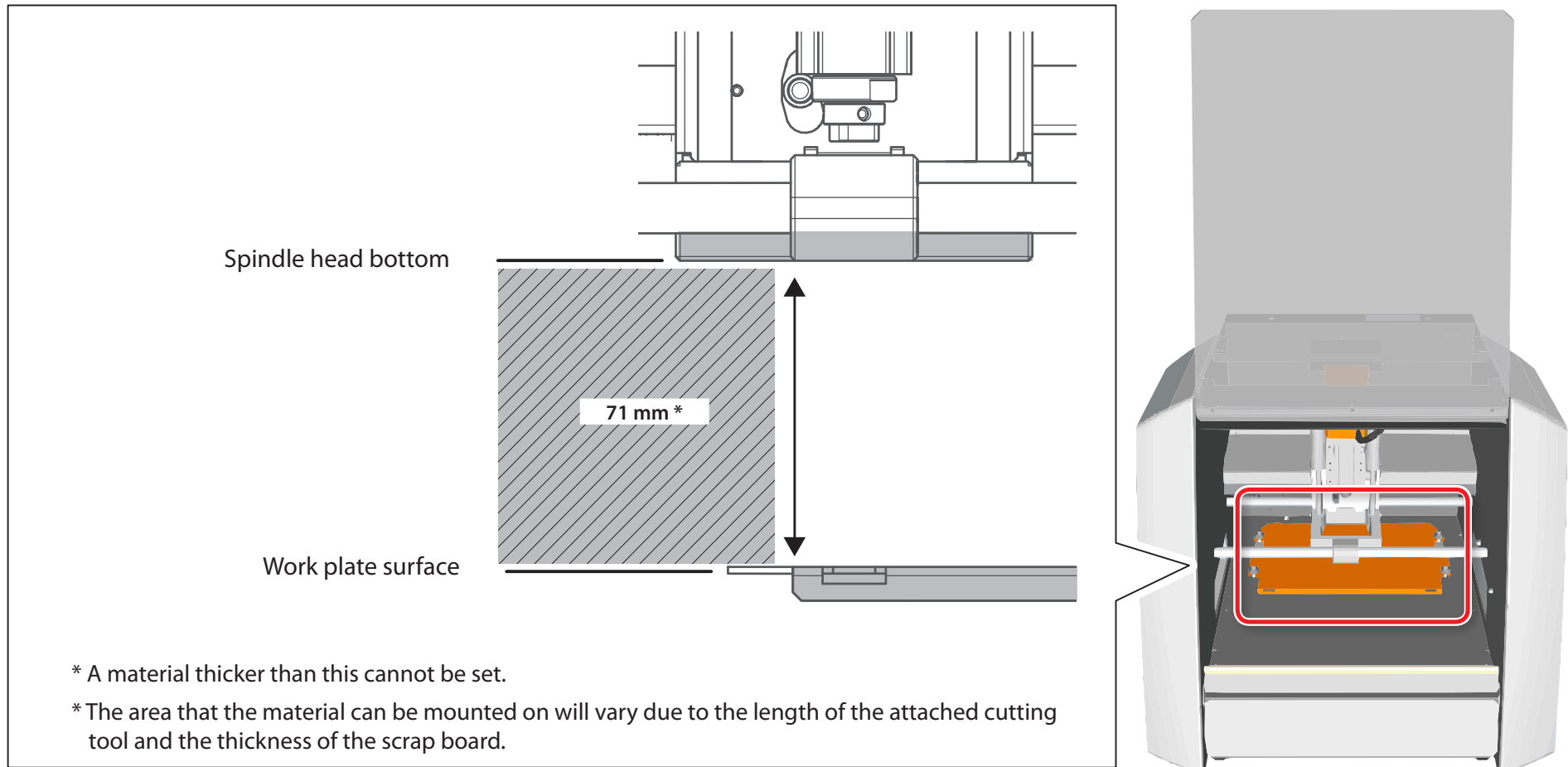

Actual Size That Can Be Cut

Creating an object of the size of the full axis travel is not necessarily possible. Because a certain amount of clearance in the X-, Y-, and Z-axis directions is required for no-load feed of the tool, the allowable size of the workpiece is reduced by a corresponding amount. Also, the possible cutting-in depth is generally determined by the length of the tool. Using a lengthy tool to achieve deep cutting reduces the clearance in the Z-axis direction, which further reduces the allowable size of the workpiece. The size of what you can cut varies according to the shape of the object you want to create and the tool you use. Give careful thought to this ahead of time, before you start work.

Z Cutting Range by Changing the Position of the Spindle Unit

There are two attachment positions (height) of a spindle unit. It uses properly with the length of a cutting tool, and the thickness of material.

☞ **"Changing the Position of a Spindle Unit"** (p. 138)

Initial setting : Low position

Spindle Unit Attachment Position

Low position

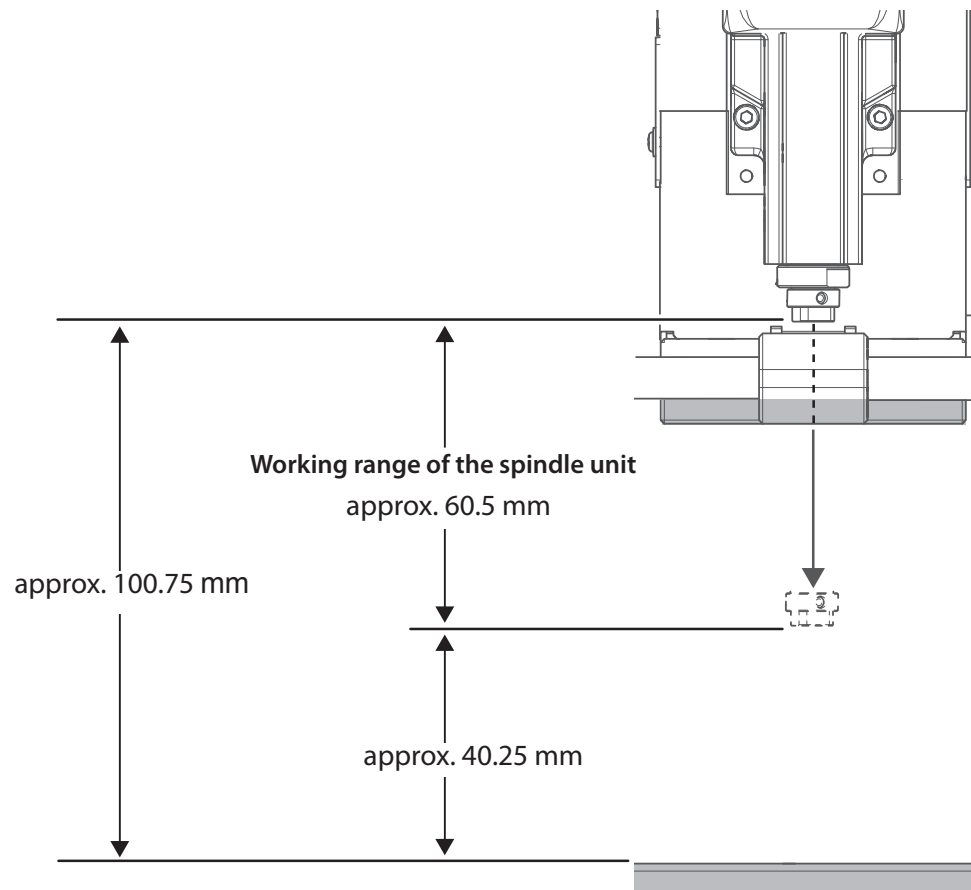

High position

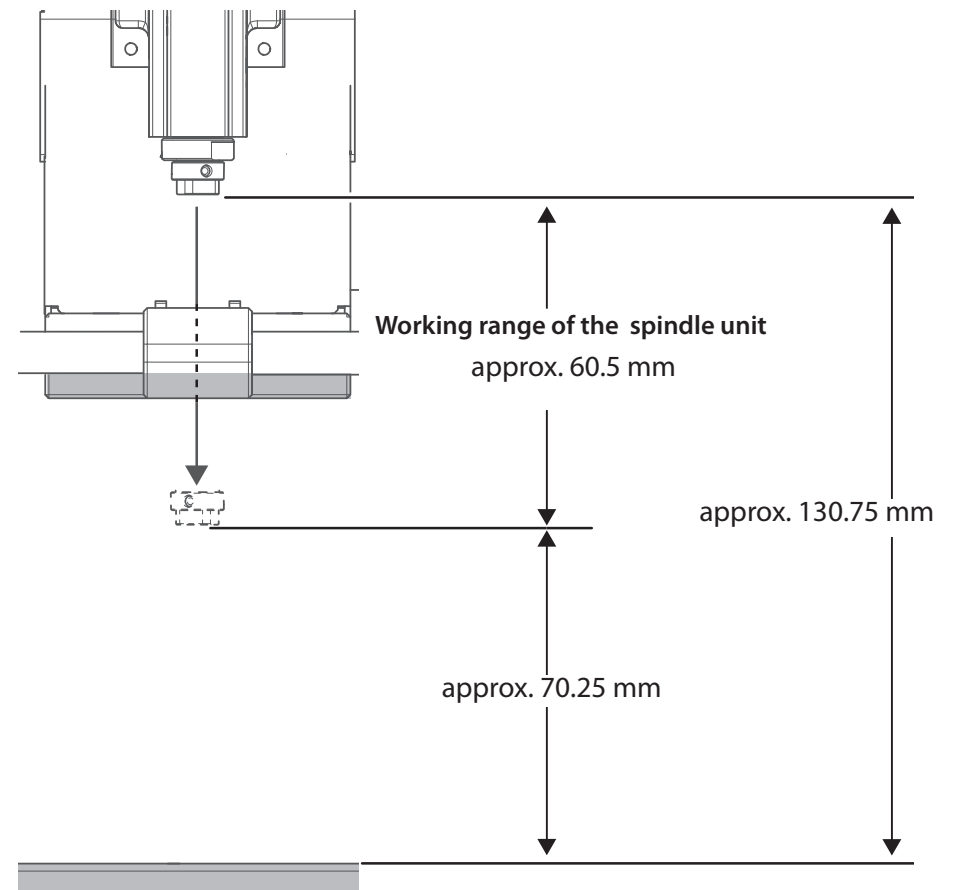

One Side Cutting

The Flow of One Side Cutting	25	MODELA Player 4	47	Cutting (One Side Cutting)	87
The Flow of One Side Cutting	25	About MODELA Player 4	47	Flow Diagram	87
Items Necessary for Cutting	26	Starting MODELA Player 4	48	STEP 1 : Attach the Material to the Table	88
Items to Prepare Yourself	28	The Name and Function of the Tool bar	49	STEP 1 : Attach the Material to the Table	88
SRP Player	29	Display Help Dialog	50	STEP 2 : Set the Origin Point.....	89
About SRP Player	29	Quit MODELA Player 4	50	STEP 3: Performing Cutting (when you are using SRP Player)	93
Starting SRP Player	30	Creating a MODELA Player 4 File	51	STEP 3: Performing Cutting (when you are using MODELA Player 4)	100
Setting Up the Output Device.....	31	STEP 1: Load the Cutting Data.....	51	STEP 4 : Remove Processed Material	102
The Name and Function of the Tool bar	36	STEP 2 : Set the Machine Selection	53	STEP 5 : Turning the Power Off	103
Display Help Dialog	37	STEP 3 : Set the Origin Point of the Model and Orientation	54	Operations Available during Cutting	104
Quit SRP Player.....	37	STEP 4 : Set the Material	57		
Creating an SRP Player File	38	STEP 5 : Set the Margin	58		
Flow Diagram	38	STEP 6 : Set the Surface leveling Process of Material	60		
STEP 1: Determine the Size and Orientation of the Model	39	STEP 7 : Confirm the Cutting Preview.....	67		
STEP 2: Determine What to Do	42	STEP 8 : Set the Roughing Process.....	69		
STEP 3 : Create the Cutting Data	43	STEP 9 : Set the Finishing Process	74		
STEP 4: Preview the Result of Cutting.....	46	Preparing the Machine	79		
		Flow Diagram	79		
		STEP 1 : Turning the Power On	80		
		STEP 2 : The Machine Run-in	81		
		STEP 3 : Confirm the Command Set	83		
		STEP 4 : Attach the Cutting Tool	84		

The Flow of One Side Cutting

The Flow of One Side Cutting

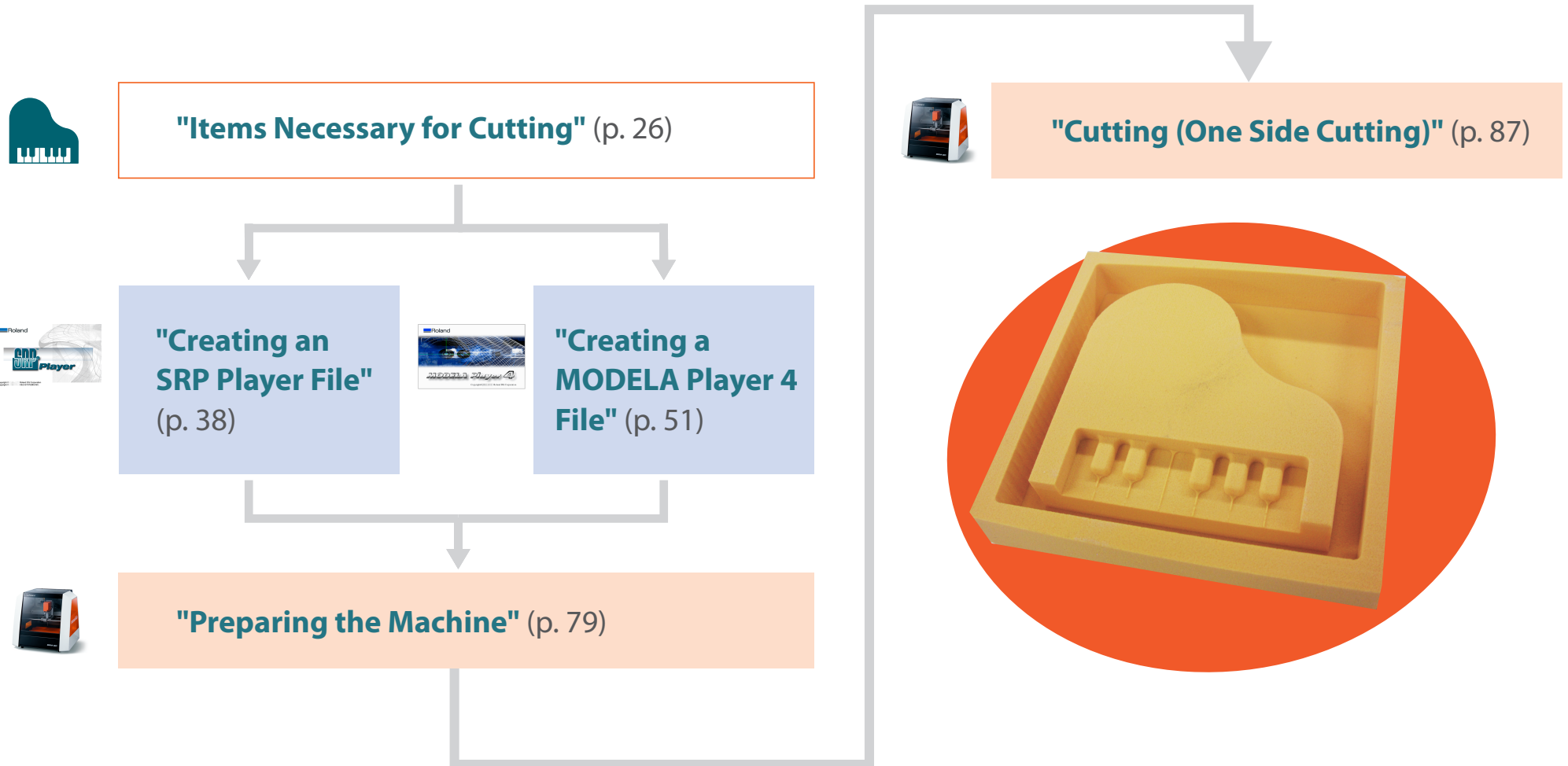

In this manual, a procedure is explained by the method using **"Piano.stl."** If it does as a procedure, it can cut, as shown in the following figure.





Items Necessary for Cutting

Software Applications Necessary For Sample Cutting

☞ Download "<http://startup.rolanddg.com>"

 <p>SRP Player</p> <p>☞ "About SRP Player" (p. 29)</p> <p>☞ "STEP 3: Performing Cutting (when you are using SRP Player)" (p. 93)</p>	 <p>MODELA Player 4</p> <p>☞ "About MODELA Player 4" (p. 47)</p> <p>☞ "STEP 3: Performing Cutting (when you are using MODELA Player 4)" (p. 100)</p>	 <p>Virtual MODELA</p>
---	---	---

Machine Accessories Necessary For Sample Cutting

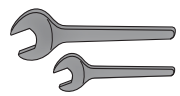
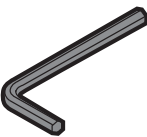
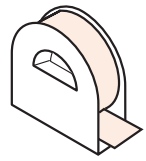
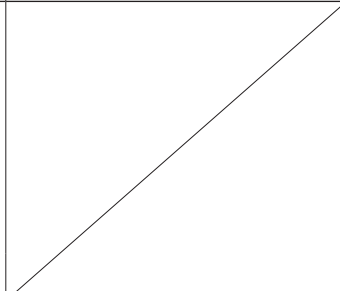
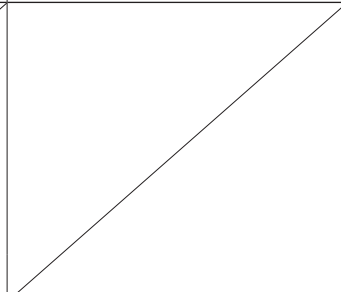
 <p>Collet (1)</p>	 <p>Cutting tool (1)</p>	 <p>Set screw (1)</p>	 <p>Spanner L / S (one for each)</p>
 <p>Hexagonal wrench, small (1)</p>	 <p>Double-stick tape (1)</p>		



Sample Cutting Data

Installing SRP Player or MODELA Player 4 installs sample data as well.

(When the SRP Player is installed on drive C)

C:\ProgramData\Roland DG Corporation\SRPPlayer\Sample

(When the installation place of MODELA Player 4 is Drive C)

C:\ProgramData\Roland DG Corporation\MODELA Player 4\Sample

"Piano.stl" Data Size

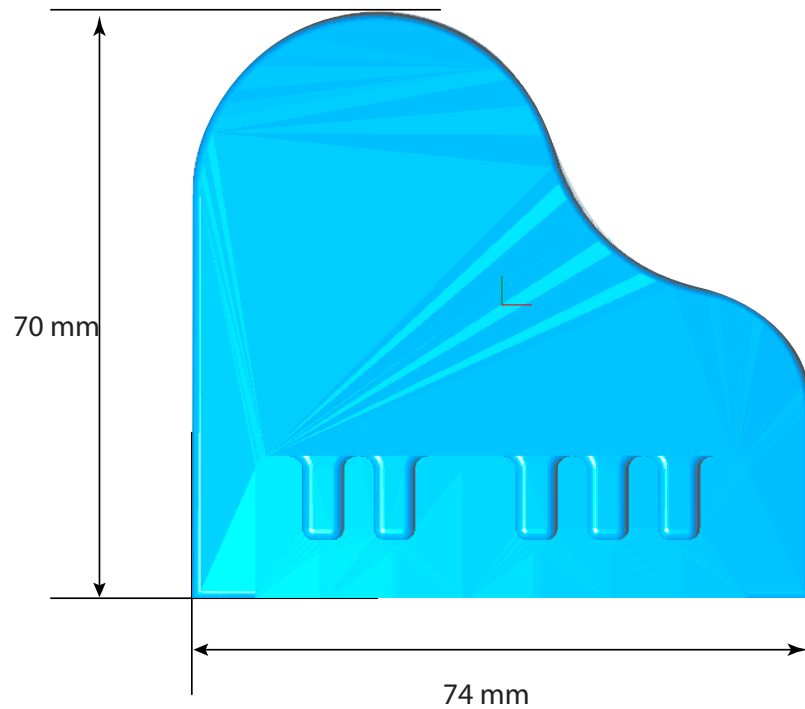



Items to Prepare Yourself

☞ "Cutting Material / Scrap Boards" (p. 20)

Material

It is necessary to prepare larger size than cutting data.

* The dimensions below are a reference size for the sample.

For both SRP Player and MODELA Player 4, the values listed in this manual assume the following material size.



The data size can be set for the size of the material.

☞ "Set the Size of Cutting Data" (p. 56)

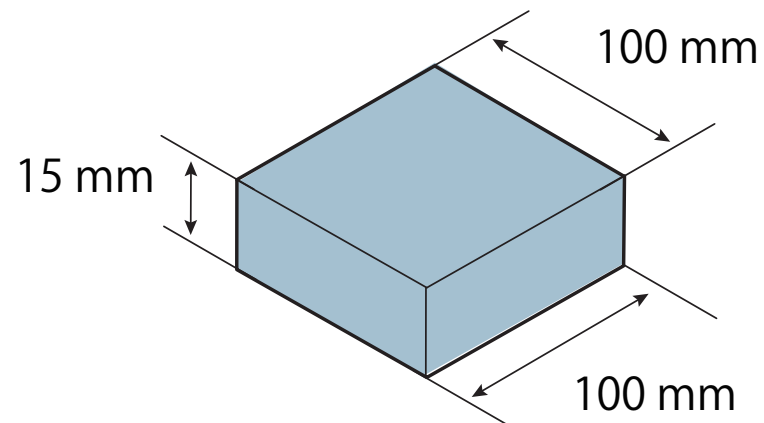

SRP Player

About SRP Player

This is a CAM software that imports general-use 3D data, (such as IGES, DXF (3D), or STL), and lets you easily prepare tool paths and output them to the SRM-20.



☞ Download "<http://startup.rolanddg.com>"





Starting SRP Player

To start SRP Player, do one of the following:

- Double-click .
- Double-click an SRP file.
- Drag an SRP file onto .

- Start from the Windows Start menu.

Windows 8.1

1. Click  on the "START" screen.
2. Click [SRP Player] on the "APPS" screen.

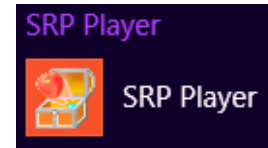

Windows 8

1. Right - click on the "START" screen.
2. Click  [All apps].
3. Click [SRP Player] icon of [SRP Player].

Windows 7

1. Click  [START] menu.
2. Click [All Programs] (or [Programs]) → [SRP Player] → [SRP Player].





Setting Up the Output Device

Configure SRP Player so that it can output data to the cutting machine.

IMPORTANT

Unless a machine setup is performed, a right setup or output cannot be performed.

When Starting SRP Player for the First Time

Following the instructions displayed in the dialog, specify the **"cutting machine to connect,"** the **"unit of length,"** and the **"cutting tool to use."**

Procedure

1. Connect the cutting machine to the computer with the USB cable and turn on the machine.

☞ **"STEP 1 : Turning the Power On"** (p. 80)

2. Start SRP Player.

This displays a dialog box for configuring the settings.

☞ **"Starting SRP Player"** (p. 30)



3. Click **Next >**.

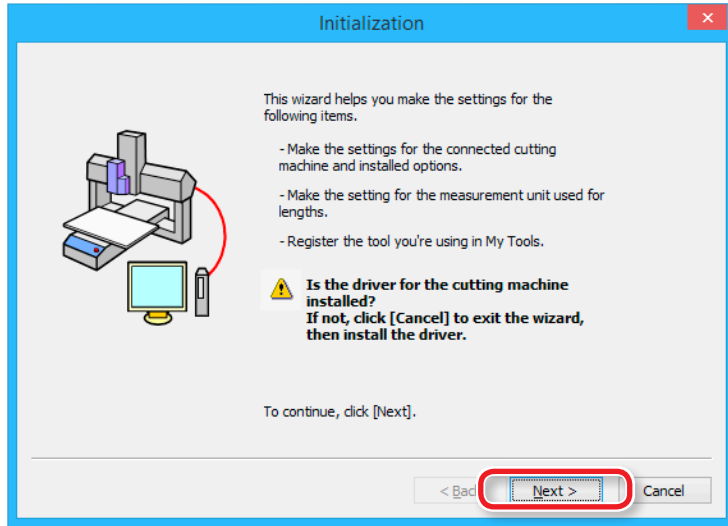

4. Select the desired cutting machine and click **Next >**.

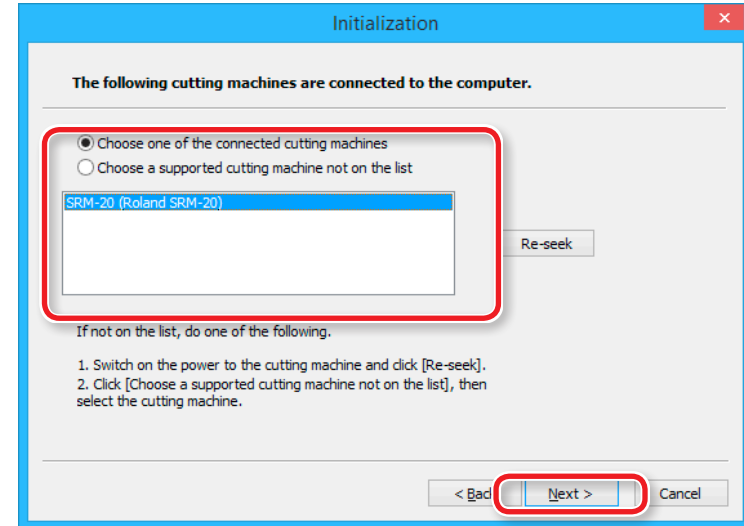

MEMO

The following dialog is displayed while the wizard is searching for cutting machines connected.

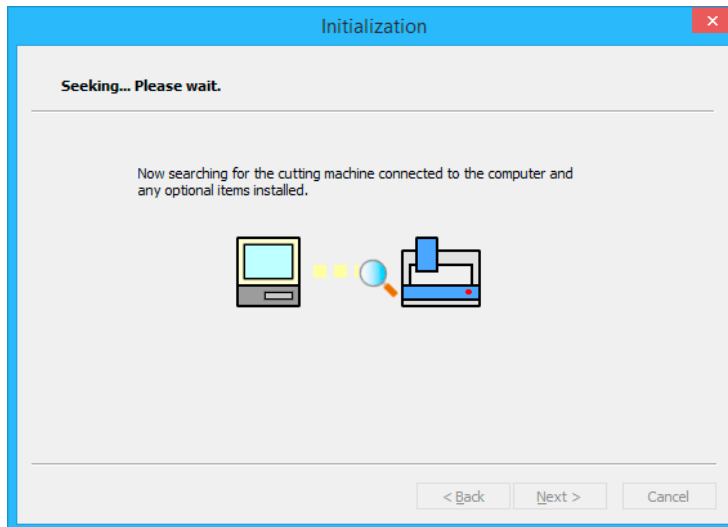



5. Click **Next >**.

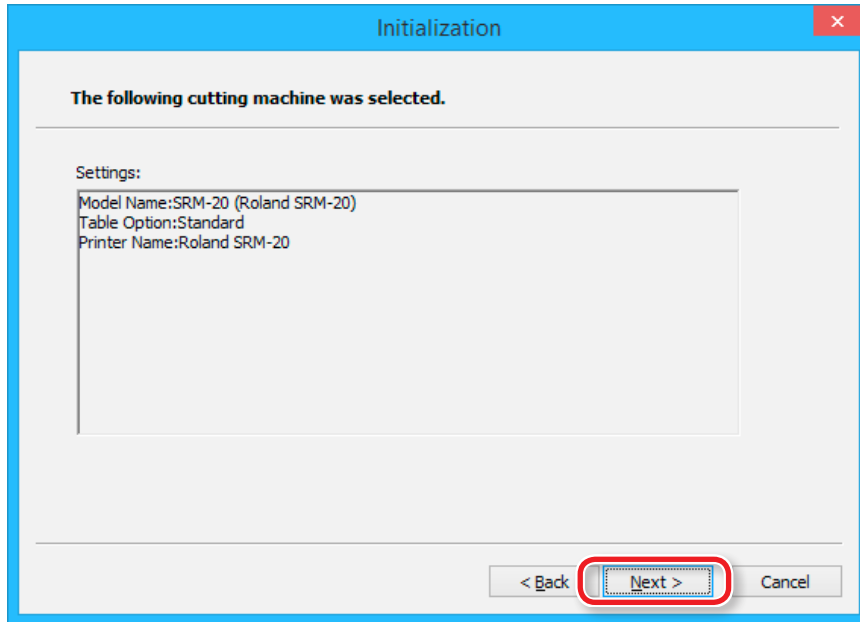

6. Select the unit of length and click **Next >**.

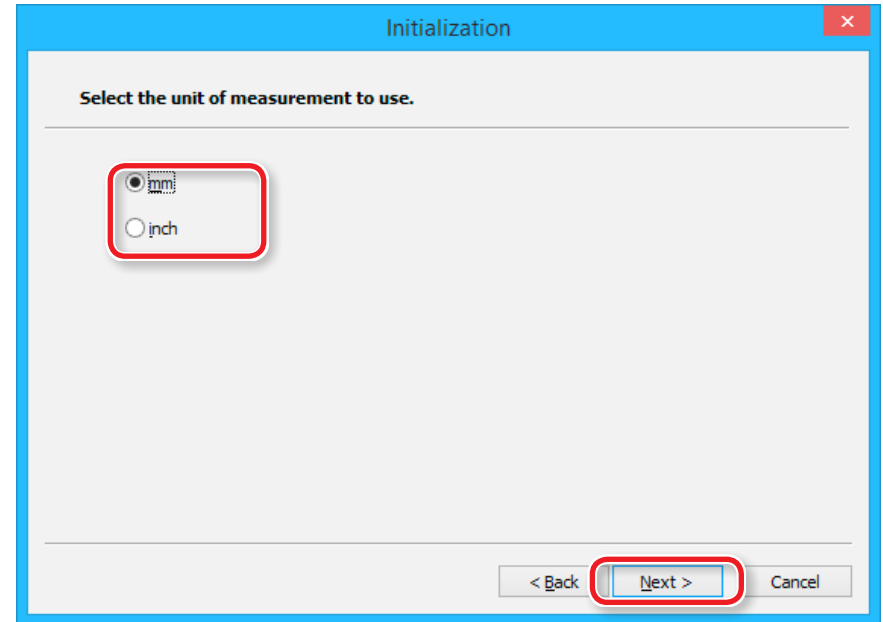



7. Register the cutting tool.

Select the check box next to the cutting tool you want to register and then click **Next >**.

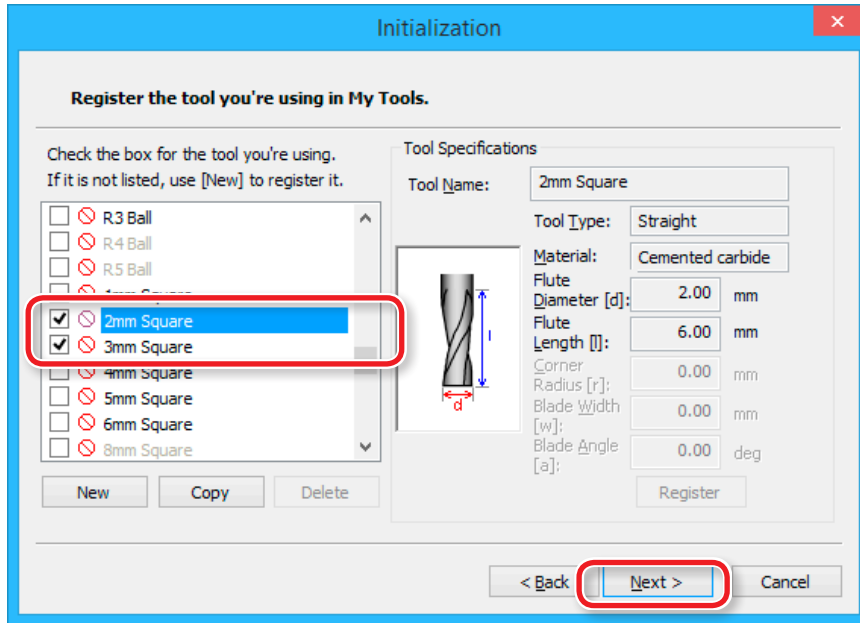

8. Click **Finish**.

This completes the settings.

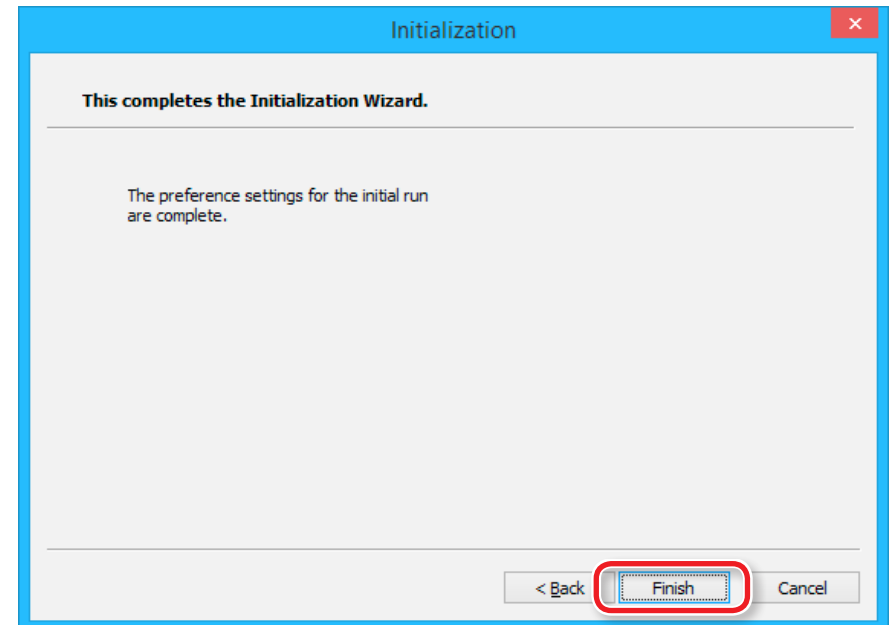



When Starting SRP Player for the Second or Subsequent Time

Procedure

1. On the menu bar, click **[File]** → **[Preferences]**.

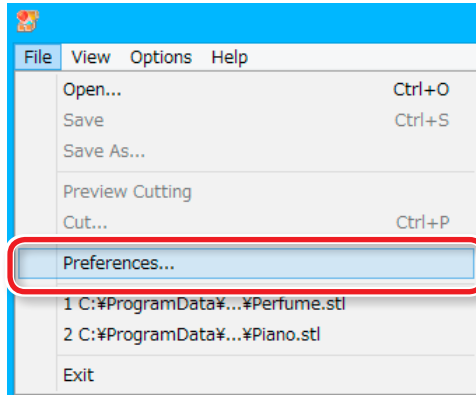

2. On the **[Preferences]** dialog, click the **[Cutting Machine]** tab.
Configure the settings.

2-1. Model Name: SRM-20

2-2. Spindle Unit: Standard

2-3. Table: Standard

2-4. Printer Name: Roland SRM-20



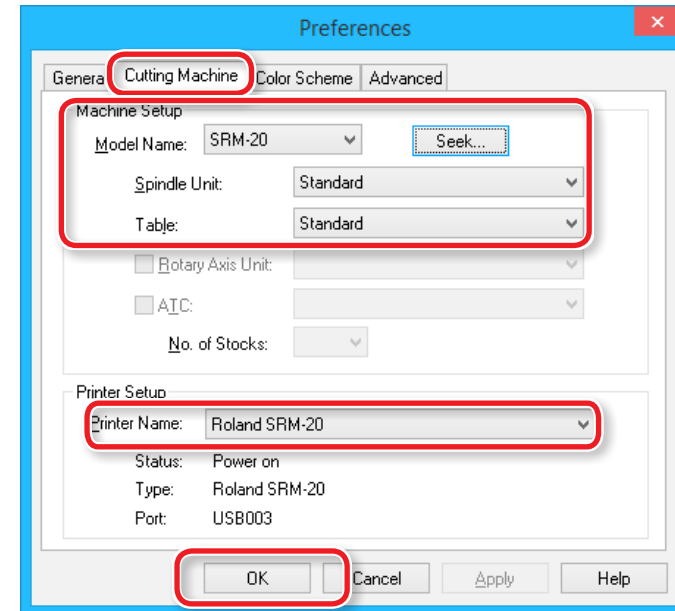



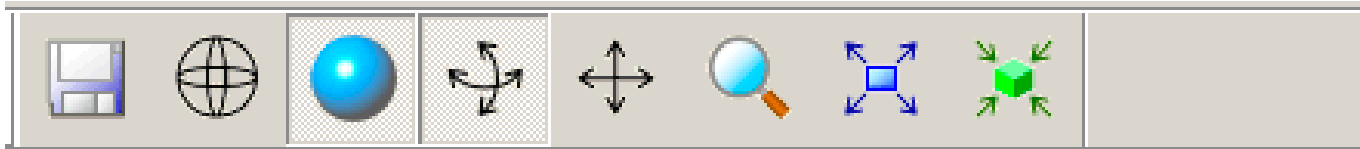

2-5. Click **[OK]**.





The Name and Function of the Tool bar



Icon	Function	Detail	Icon	Function	Detail
	Save	Simply saves the current project file without changing its name or location.		Zoom in/out	Zooms in or out the model. Clicking the left mouse button shows an enlarged view of the model with the point where you clicked at the center. You can select the area to zoom by dragging. Clicking the right mouse button shows a reduced-size view.
	Wireframe	Displays the object using only a gridwork of lines.		Pan (move)	Allows you to move the model by left-clicking and dragging it. This is useful to view parts of the object that lie beyond the edge of the window.
	Shading	Displays the object with colored and shaded surfaces.		Fit to screen	Expands or reduces the size of the object shown to fill the screen.
	Rotate	Allows you to rotate the main view by dragging the mouse so that you can view the object from a different perspective.		Default View	Resets the current [View] menu settings (Perspective/Top/Front/Side) to the default settings.



Display Help Dialog

The basic operation and the processing procedure of SRP Player can be checked.

Procedure

1. On the menu bar, click [Help].
2. Click [Contents].

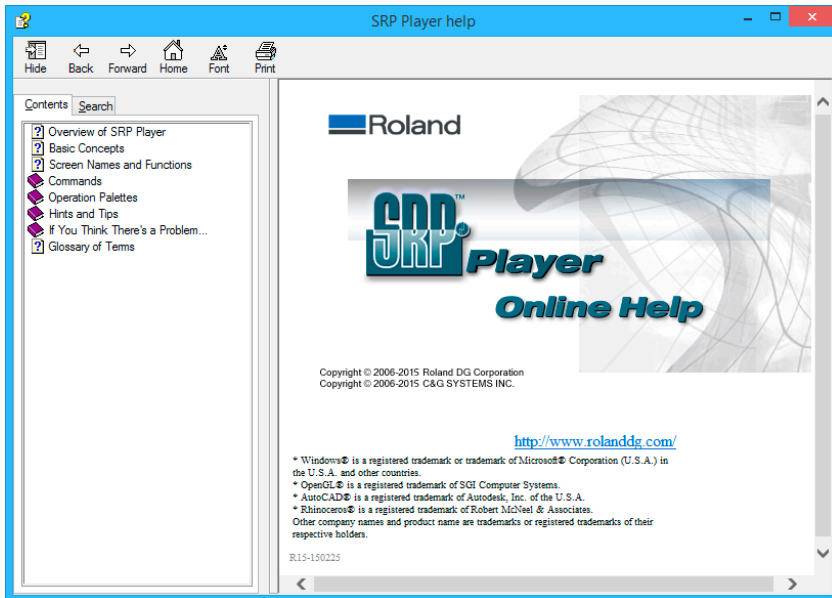

Quit SRP Player

Click  on the main screen.

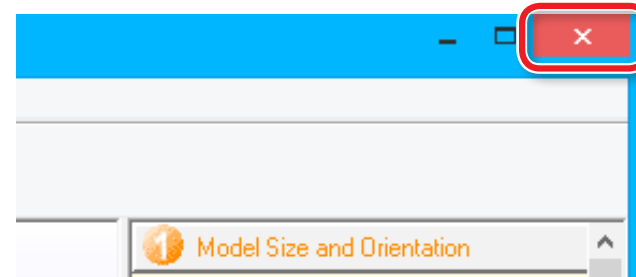

Creating an SRP Player File

Flow Diagram

"STEP 1: Determine the Size and Orientation of the Model" (p. 39)



"STEP 2: Determine What to Do" (p. 42)



"STEP 3 : Create the Cutting Data" (p. 43)



"STEP 4: Preview the Result of Cutting" (p. 46)

STEP 1: Determine the Size and Orientation of the Model

Load an IGES, DXF (3D), or STL format file to set the size and orientation.

MEMO

For details on how to change the settings, see the [\[Help\]](#).

☞ ["Display Help Dialog"](#) (p. 37)

Procedure

1. Start SRP Player.

☞ ["Starting SRP Player"](#) (p. 30)

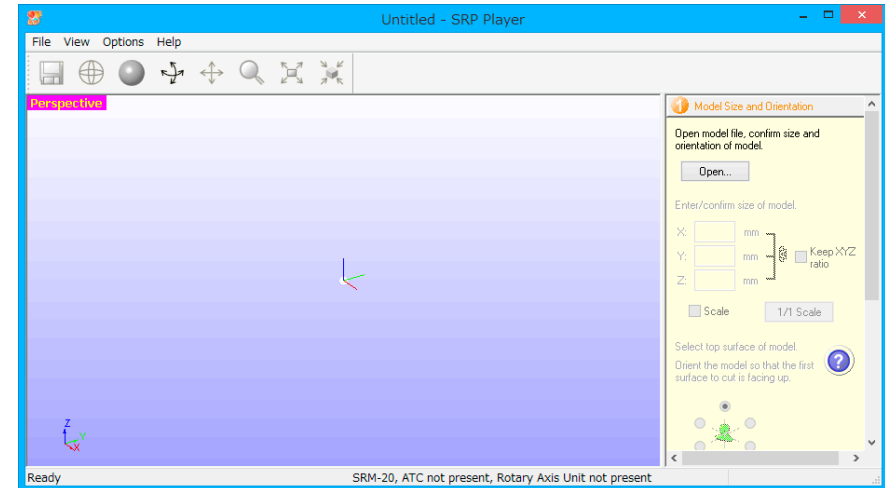

☞ ["The Name and Function of the Tool bar"](#) (p. 36)



2. Open the cutting data model.

2-1. Click [Open].

2-2. Select the cutting data model ("Piano.stl"), and click [Open (O)].

Storage location of sample cutting data model

C:\ProgramData\Roland DG Corporation\SRP Player\Sample

(when the SRP Player is installed on drive C)

☞ "Sample Cutting Data" (p. 27)

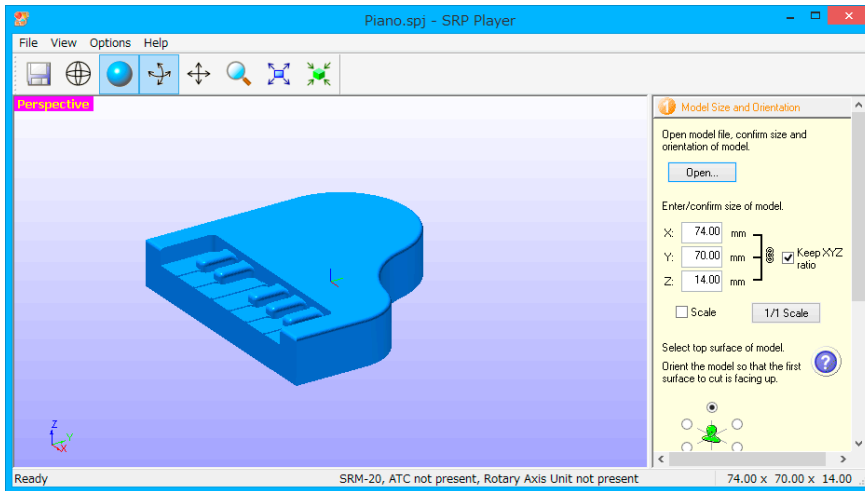

MEMO

The change of a display screen can be performed by  on the toolbar.

☞ "The Name and Function of the Tool bar" (p. 36)

MEMO

Alternatively, you can also switch to a particular screen by choosing [Perspective], [Top], [Front], or [Side] from the [View] menu on the menu bar.

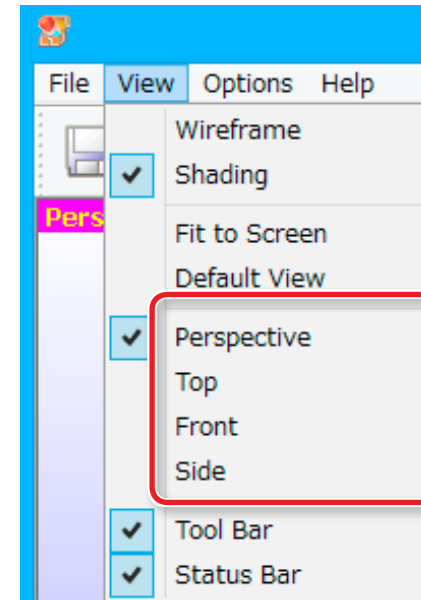



3. Configure the size settings in the cutting data.

The dialog displays the X, Y, and Z size settings for the currently open model. You can change the size settings by entering new values into the X, Y, and Z boxes.

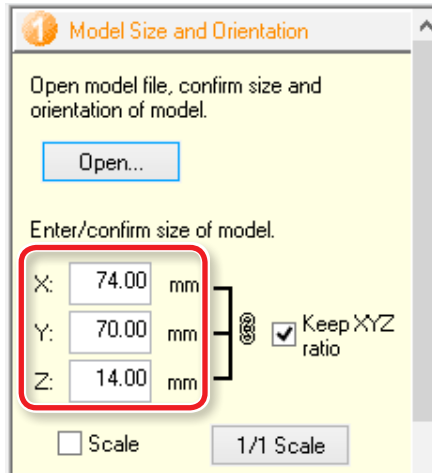

MEMO

Clicking restores the original size.

MEMO

When the **[Scale]** check box is selected, you can enter the model size settings as a percentage.

4. Select the top surface of the cutting data model.

Turn up the face that will be ground first.

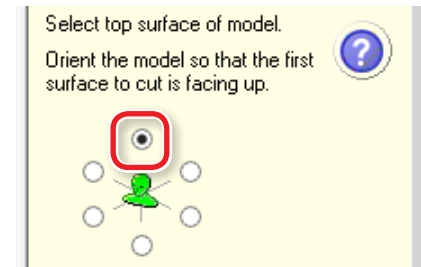

Changing the top surface changes the X, Y, and Z dimension values as well. A message appears if the size exceeds the movable range of the machine. Follow the prompts and take action accordingly.

STEP 2: Determine What to Do

Procedure

1. Click  Type of Milling.

2. Select any options that suit your needs.

This example assumes that the following options are configured:

- [Better surface finish]
- [Model with many flat planes]
- [Block workpiece]
[Cut top only]

MEMO

For details on selection criteria, see the [Help].

☞ "Display Help Dialog" (p. 37)



IMPORTANT

You have to configure all the settings before you can proceed to STEP 3.

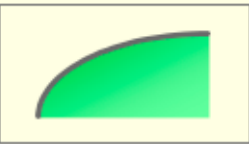

2 Type of Milling

Select the type of milling.

Better surface finish
 Faster cutting time

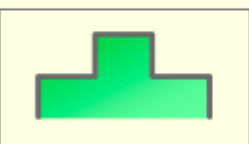

Model with many flat planes
 Model with many curved surfaces

Cylindrical workpiece
 Block workpiece

Cut top only
 Cut top and bottom

Add support to model

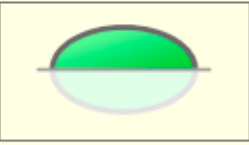
Eccentricity...
Edit...

STEP 3 : Create the Cutting Data

Procedure

1. Click .

2. Select the material.

Choose a workpiece material from the pull-down list.

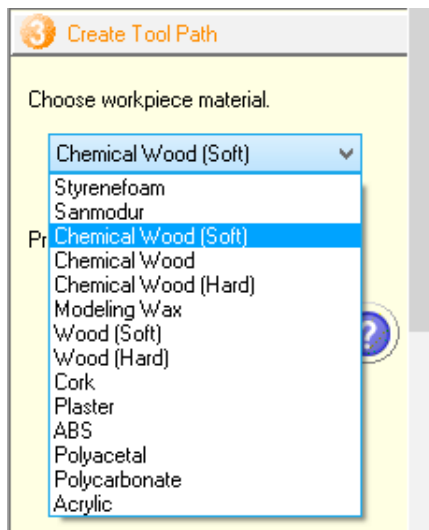

IMPORTANT

Be sure to select a correct material. Selecting a wrong material would result in failure to correctly configure the cutting conditions.



3. Set the material size.

Set the material size so that it fits the cutting data model size and the size of the part you want to create.

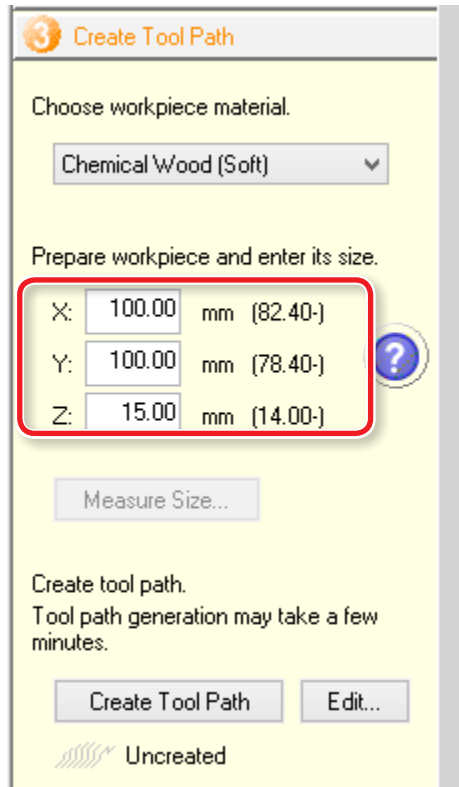

This example assumes that the following options are configured:

X = 100 mm

Y = 100 mm

Z = 15 mm

☞ "Items to Prepare Yourself" (p. 28)

MEMO

The main view displays the material shape according to the dimension values you have entered.

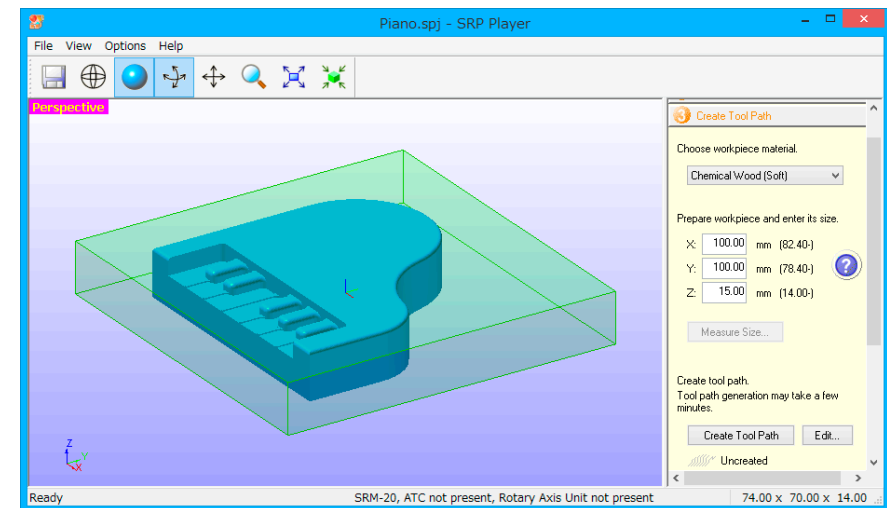

MEMO

For details on how to change the settings, see the [\[Help\]](#).

☞ "Display Help Dialog" (p. 37)

MEMO



Minimum material dimension values appear in parentheses.

You cannot enter a dimension smaller than the minimum.

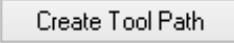

4. Create the cutting data (tool path).

Click .

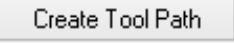
Once the cutting data (tool path) has been generated,  **[Uncreated]** changes to  **[Created]** under .

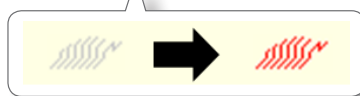
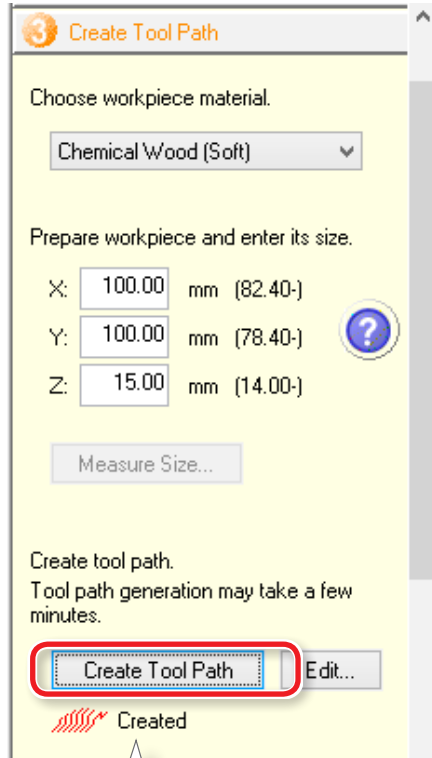

MEMO

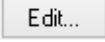
Clicking  allows you to change the detailed settings of the cutting data.

STEP 4: Preview the Result of Cutting

You can display a 3D preview of the result of cutting for simulation. You can also check a rough guide for the time that it will take for cutting.

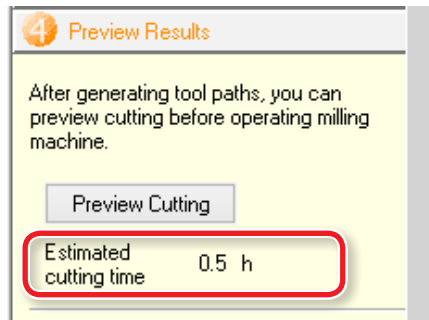

Procedure

1. Click .

2. Click .

The main view displays the preview.

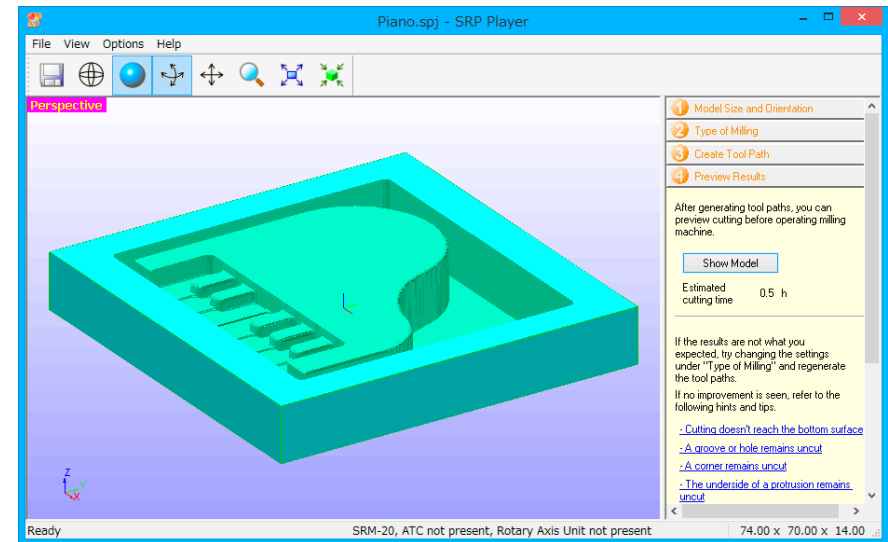

If the preview is satisfactory, proceed to **"Preparing the Machine."**

☞ **"Preparing the Machine"** (p. 79)

MEMO

You can save the cutting data by clicking **[File]** → **[Save As...]**.

MODELA Player 4

About MODELA Player 4

This is a CAM software that imports general-use 3D data, (such as IGES, DXF (3D), or STL), and lets you easily prepare tool paths and output them to the SRM-20.

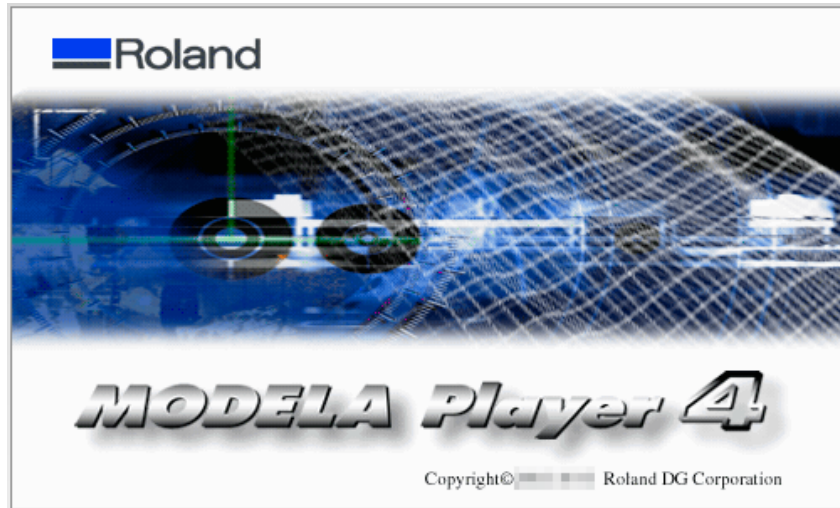

☞ Download "<http://startup.rolanddg.com>"





Starting MODELA Player 4

To start MODELA Player 4, do one of the following:

- Double-click .
- Double-click a mpj file.
- Drag a mpj file onto .

- Start MODELA Player 4 from the Windows Start menu.

Windows 8.1

1. Click  on the “START” screen.
2. Click [**MODELA Player 4**] in the “APPS” screen.

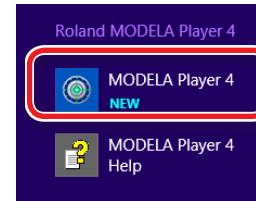

Windows 8

1. Right - click on the “START” screen.
2. Click  [All apps].
3. Click [MODELA Player 4] icon of [Roland MODELA Player 4].

Windows 7

1. Click  [START] menu.
2. Click [All Programs] (or [Program]) → [Roland MODELA Player 4] → [MODELA Player 4].

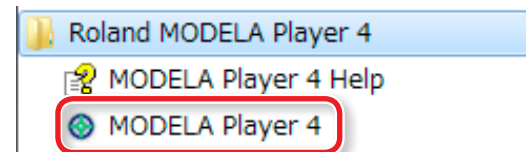

The Name and Function of the Tool bar



Icon	Function	Detail	Icon	Function	Detail
	Open	You can open either 3D data in IGES, DXF (3D), or STL format, or existing project files. You can also open project files in MODELA Player version 3 or later.		Fit to Screen	This command expands or reduces the size of the object shown to fill the screen. When you're in split view, this command affects only the active window. To apply it to all windows, hold down the [Ctrl] key and run the command.
	Save	This command saves the project with its present name.		Default View	This restores the point of view in effect just after you imported the model, and zooms the view in or out to fit it to the window. When you're in split view, this command affects only the active window. To apply it to all windows, hold down the [Ctrl] key and run the command.
	Wire Frame	This command displays the object using only a gridwork of lines.		Perspective	This displays objects drawn using the perspective projection method.
	Hide Lines	This command creates a wire frame on the surface and deletes the hidden lines at the back of the surface.		Top	This displays objects drawn on the XY plane using the parallel projection method.
	Rendering	This command adds color and shadowing to the displayed object.		Front	This displays objects drawn on the XZ plane using the parallel projection method.
	Rotate	This command allows the model to be rotated by dragging with the mouse to change the angle of view.		Side	This displays objects drawn on the YZ plane using the parallel projection method.
	Move	This command lets you move the model by dragging with the mouse.		Split	This splits the window into four parts and displays the Perspective, Top, Front, and Side views simultaneously.
	Zoom In / Out	This command enlarges or reduces the view of the model. Clicking the left mouse button shows an enlarged view with the point where you clicked at the center. You can select the area to zoom by dragging. Clicking the right mouse button shows a reduced-size view.			



Display Help Dialog

The basic operation and the processing procedure of MODELA Player 4 can be checked.

Procedure

1. On the menu bar, click [Help].
2. Click [Contents].

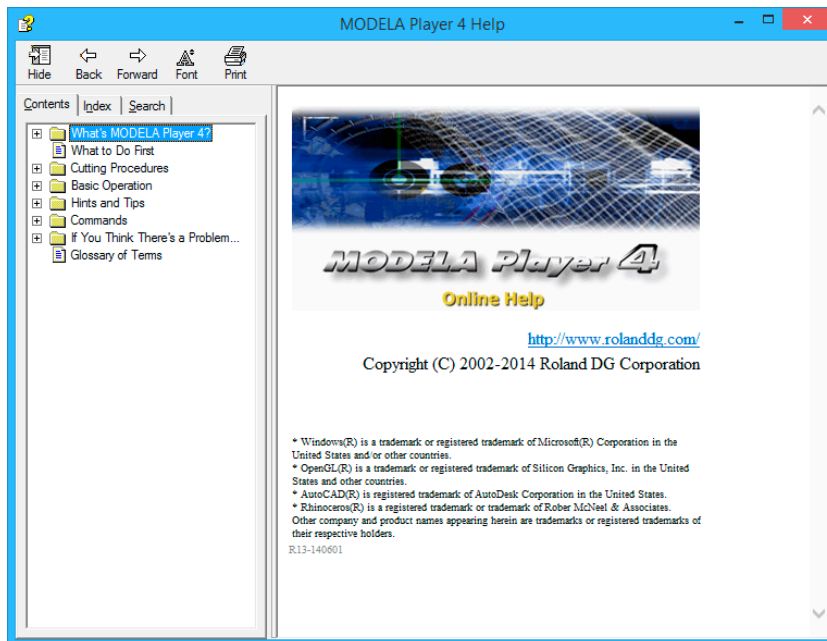

Quit MODELA Player 4

Click  on the main screen.



STEP 1: Load the Cutting Data

You can import a file in IGES, DXF (3D), STL, or MODELA Player (Ver. 3 or later) format.

☞ **"Sample Cutting Data"** (p. 27)

Procedure

1. Start MODELA Player 4.

Double - click .

☞ **"Starting MODELA Player 4"** (p. 48)

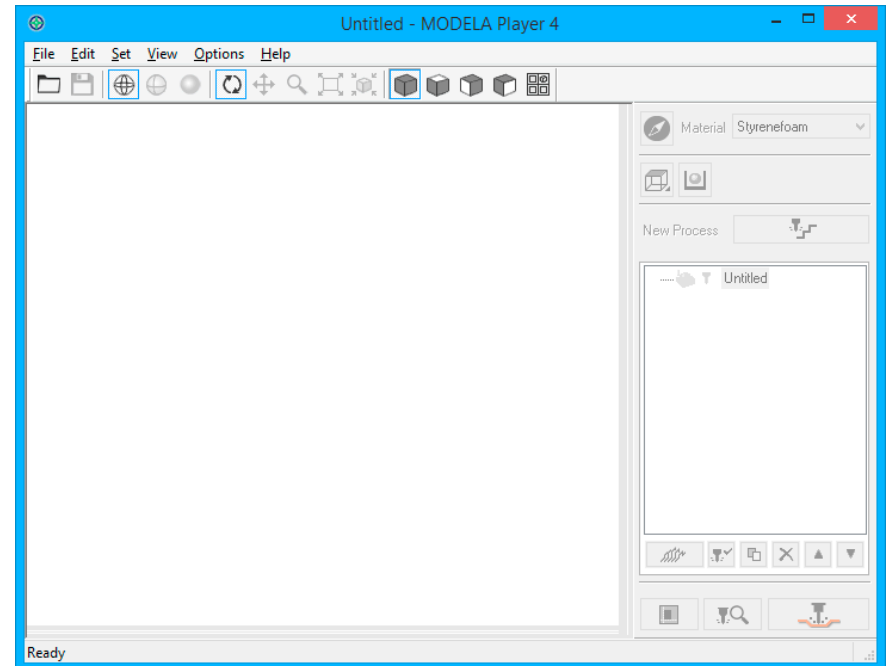

☞ **"The Name and Function of the Tool bar"** (p. 49)

☞ **"Display Help Dialog"** (p. 50)



2. Click [File] - [Open], and select "Piano.stl"

C:\ProgramData\Roland DG Corporation\MODELA Player 4\Sample
(When the installation place of MODELA Player 4 is Drive C)

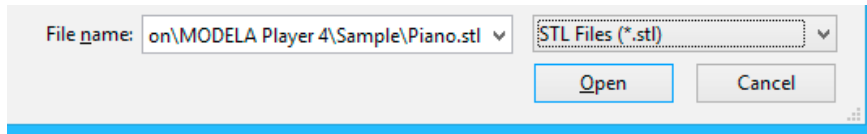

☞ "Sample Cutting Data" (p. 27)

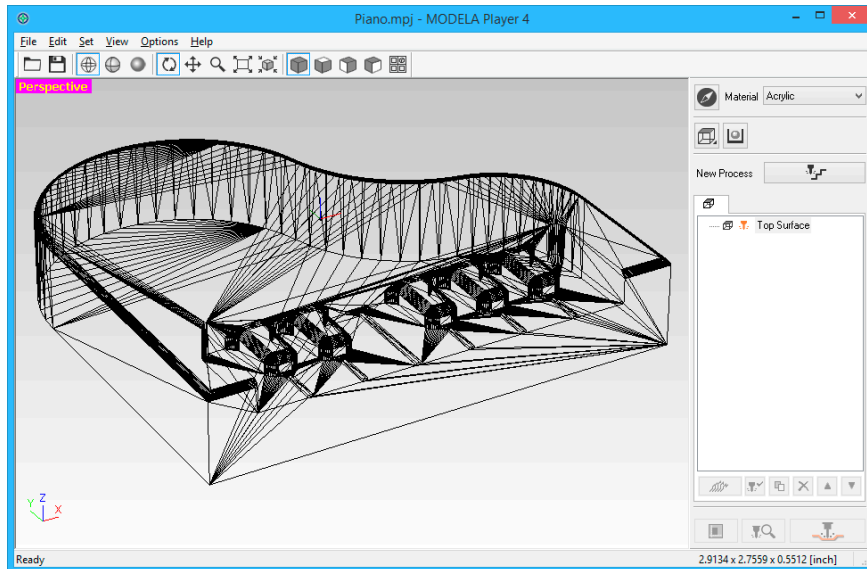

MEMO

The change of a display screen can be performed by  on the tool bar.

☞ "The Name and Function of the Tool bar" (p. 49)

STEP 2 : Set the Machine Selection

Configure MODELA Player 4 so that it can output data to the cutting machine.

IMPORTANT

Unless a machine setup is performed, a right setup or output cannot be performed.

Procedure

1. Click [File] - [Select Machine].

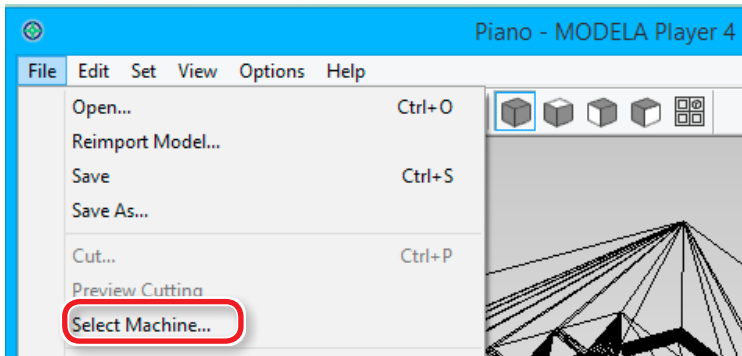

2. Set the machine selection.

- 2-1. Model Name : **[SRM-20]**
- 2-2. Command Set : **[RML-1]** Spindle Unit : **[Standard]**
- 2-3. Printer Name : **[Roland SRM-20]**
- 2-4. Click **[OK]**.

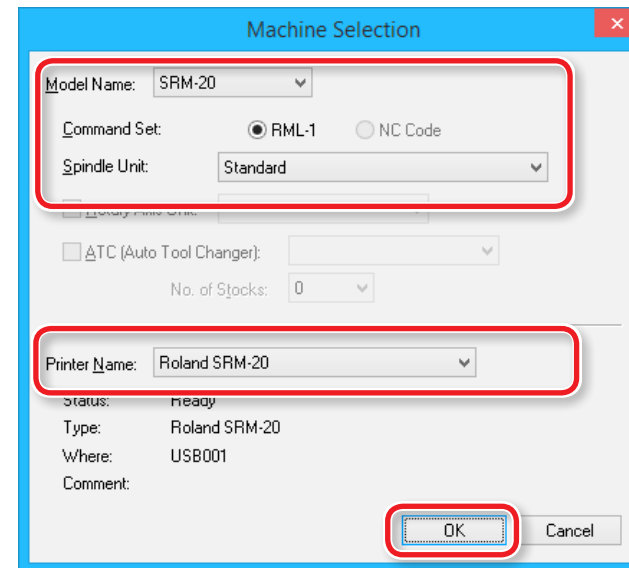



STEP 3 : Set the Origin Point of the Model and Orientation

Origin point of the Model / Origin point

- Origin point of the model : XY origin point set up on cutting data (The origin point on the data of MODELA Player 4)
- Origin point : XY origin point set up on the machine (Can be set anywhere in the cutting area)

Relation between the origin point of the model and the origin point

Set up the origin point of the model and the origin point of the machine to become the same position.

Origin point : Center
Origin point of the model : Center

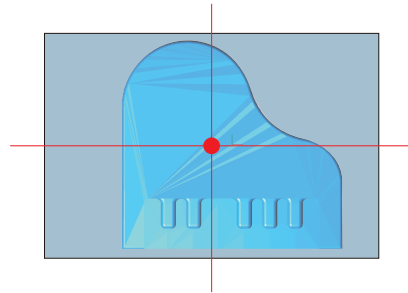

OK

Origin point : Lower left
Origin point of the model : Center

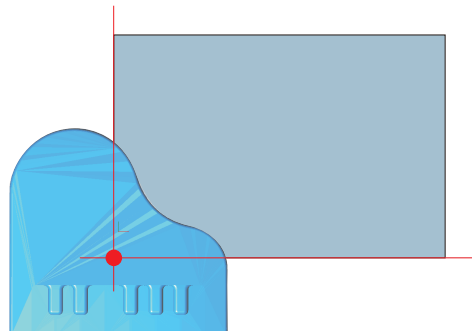

NG



Procedure

1. Click  [Model].

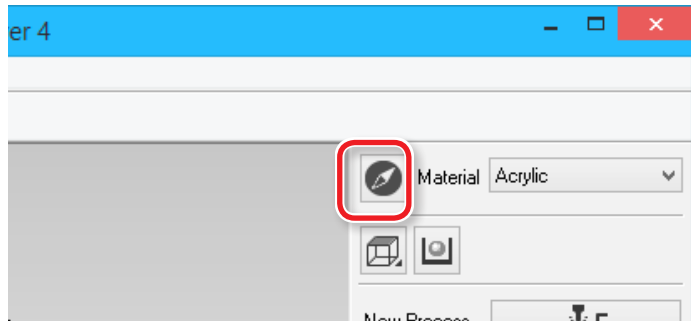

2. Set [Selected Top Surface].

"Piano.stl" : Following figure → [OK]

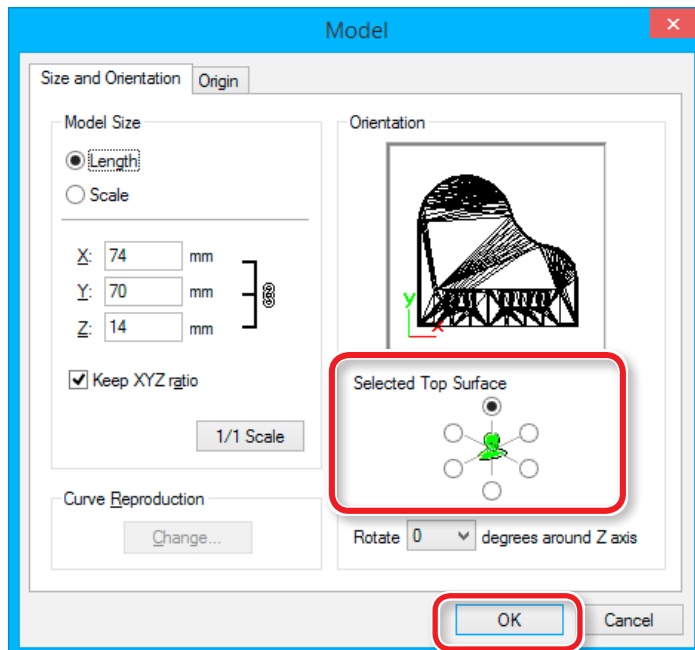

3. Set the origin point of the model.

Click the "Origin" tab, select the origin position.

"Piano.stl" : Center of the model → [OK]

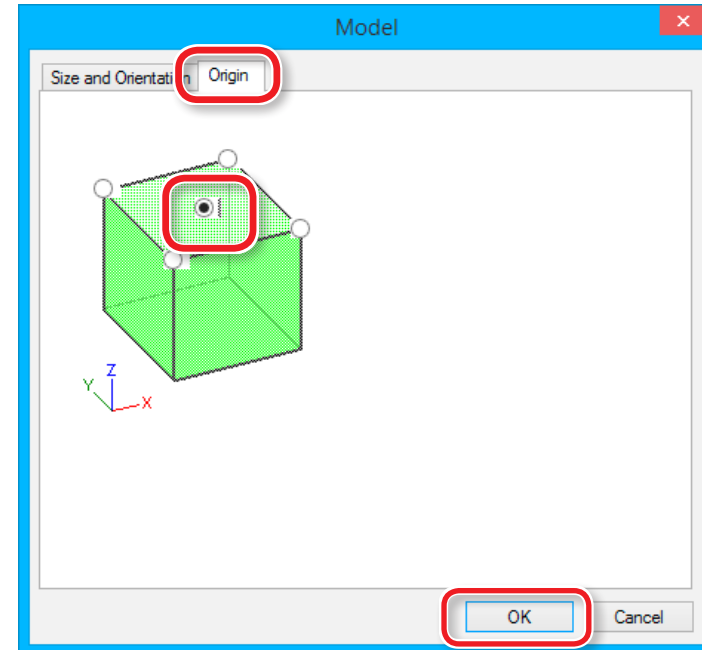



Set the Size of Cutting Data

Cutting data size can be changed on MODELA Player 4 to arrange data size with material.

Click  [Model].

Input the "Model Size" values to change the size.

Click [1/1 Scale] to return to the original size.

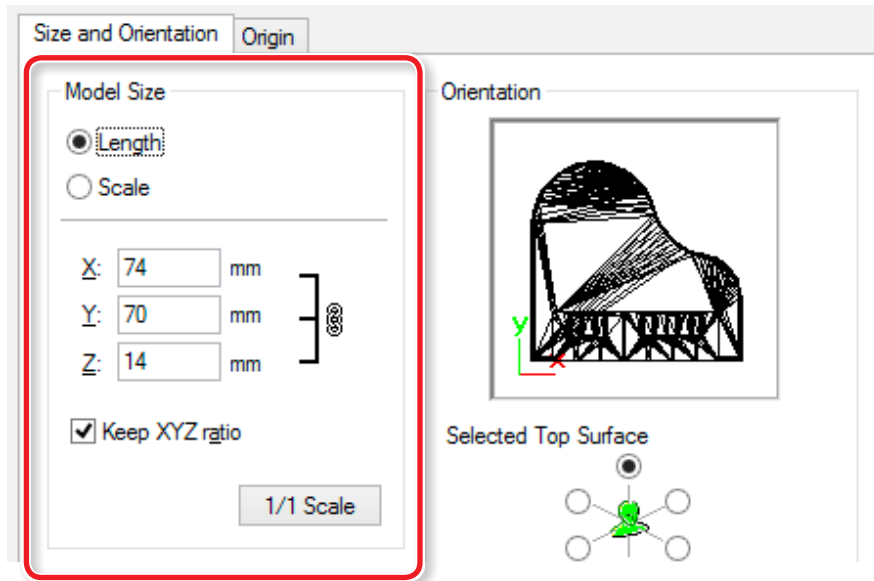

The size of cutting data can be checked at the lower right on the main screen.

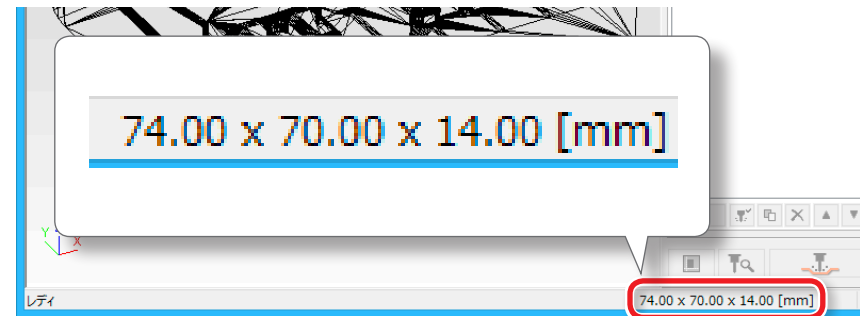



STEP 4 : Set the Material

Select the quality of the material. Set the type of prepared material.

☞ **"Material Types"** (p. 20)

MEMO

Set up the quality of the material before process creation.

Because changing the composition also produces changes in the cutting tool and the cutting parameters, changing the composition after you have created the processes is not recommended.

Select the material.

Choose a workpiece material from the pull-down list.

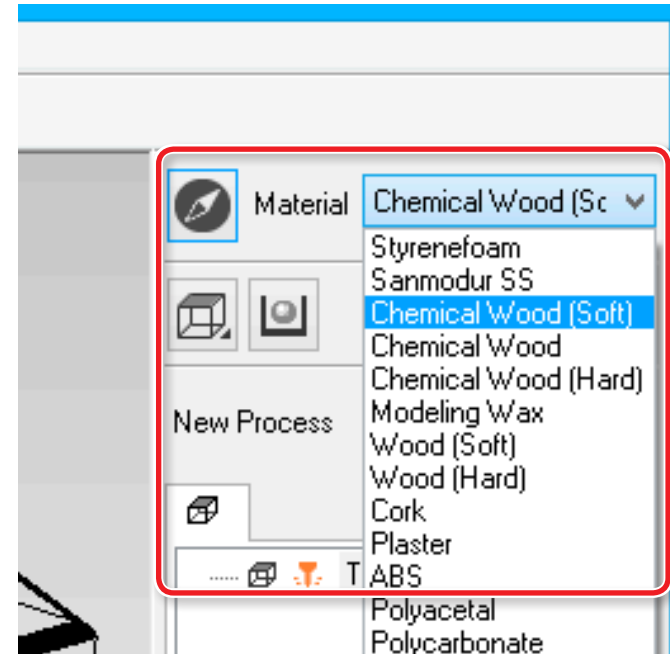



STEP 5 : Set the Margin

Margin

Make settings for the space around the model to provide approach paths for the cutting tool.

Procedure

1. Click  [Modeling Form].

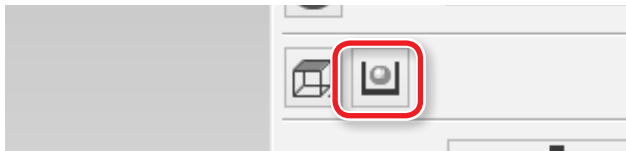

2. Select the margin setting.

"Piano.stl" : [Automatic] → [OK]

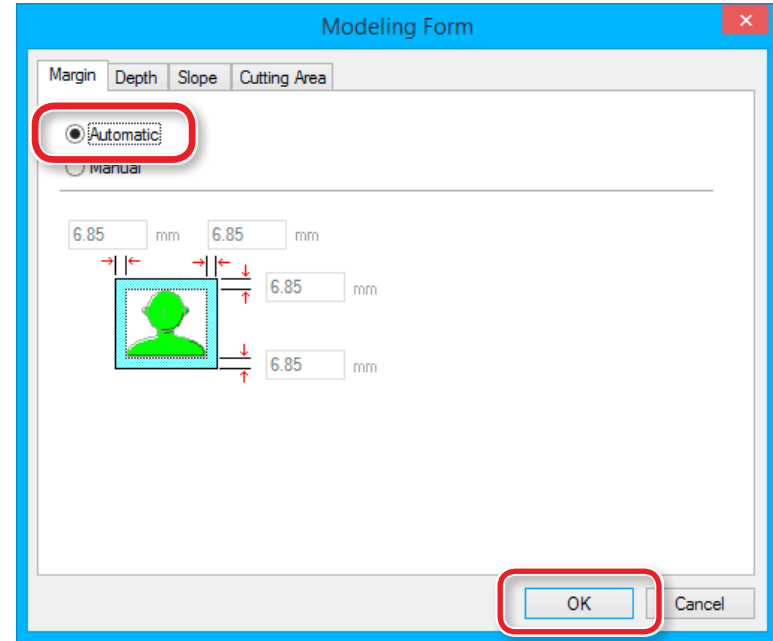

[Automatic]

Sets a front and rear, right and left margin of 6.85 mm.

[Manual]

Enter the desired margin space.



The Cutting Area is Different Depending on the Margin Settings

<When no-margin (0 mm) is set up >

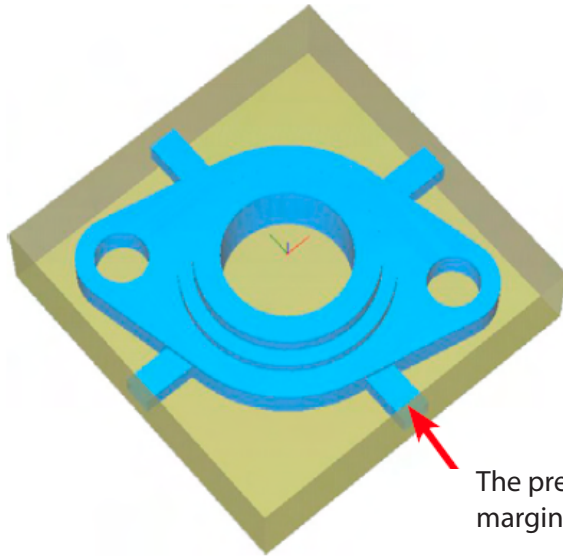

The preview when you set margin "**0 mm.**"

<When margin (arbitrary numbers) is set up >

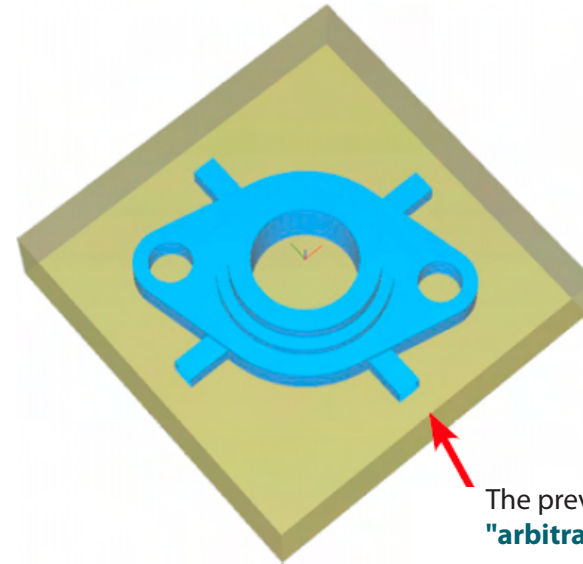

The preview when you set margin "**arbitrary numbers.**"



STEP 6 : Set the Surface leveling Process of Material

Surface leveling of material

Leveling eliminates unevenness in the surface of a material to create a work plane that is parallel with the cutting plane along which the cutting tool moves.

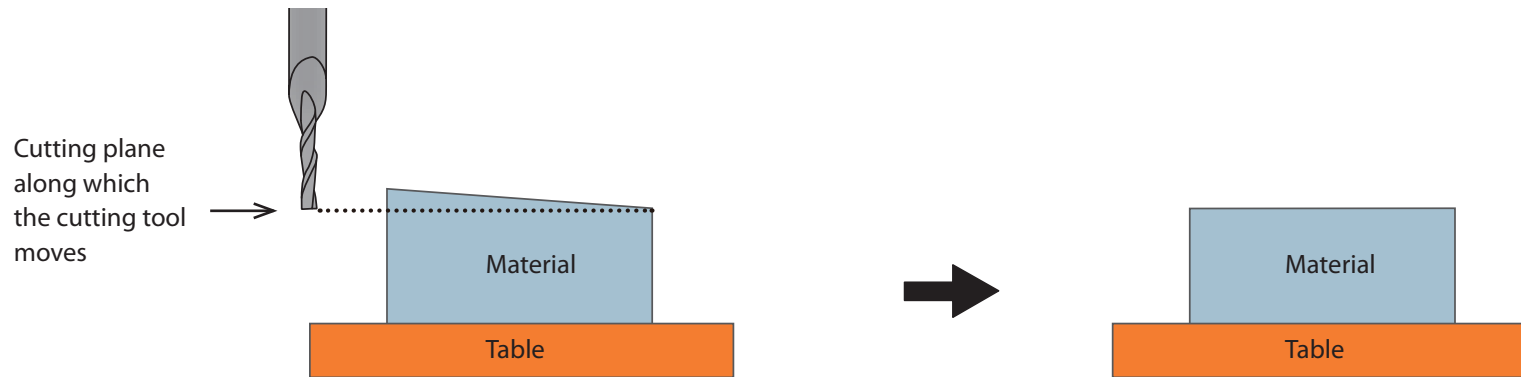

"Piano.stl"

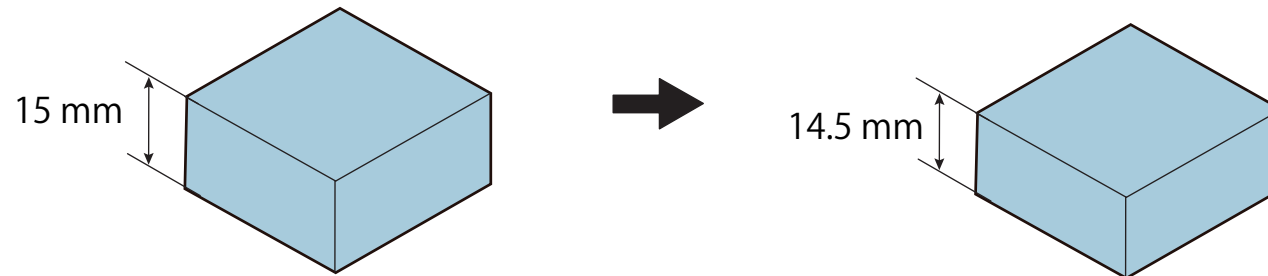



Procedure

1. Create the surface leveling process of material.

Click  [New Process].

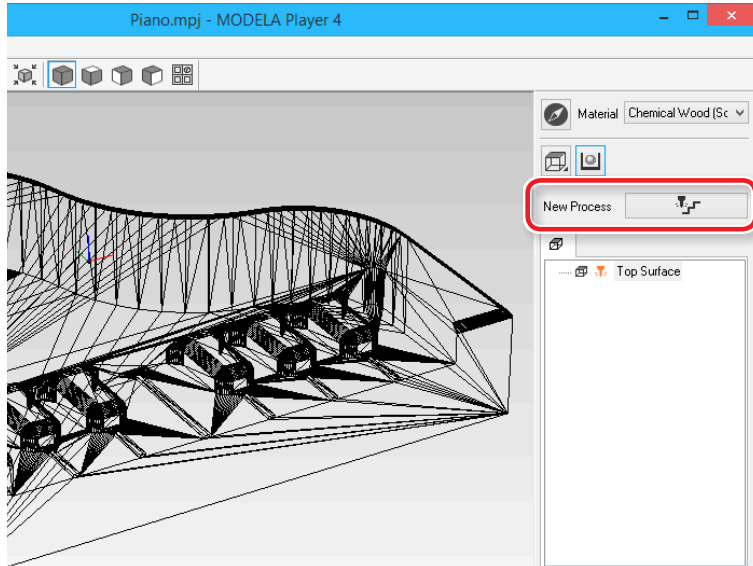

2. Set the type of process.

Select [**Surfacing**], then click [**Next**].

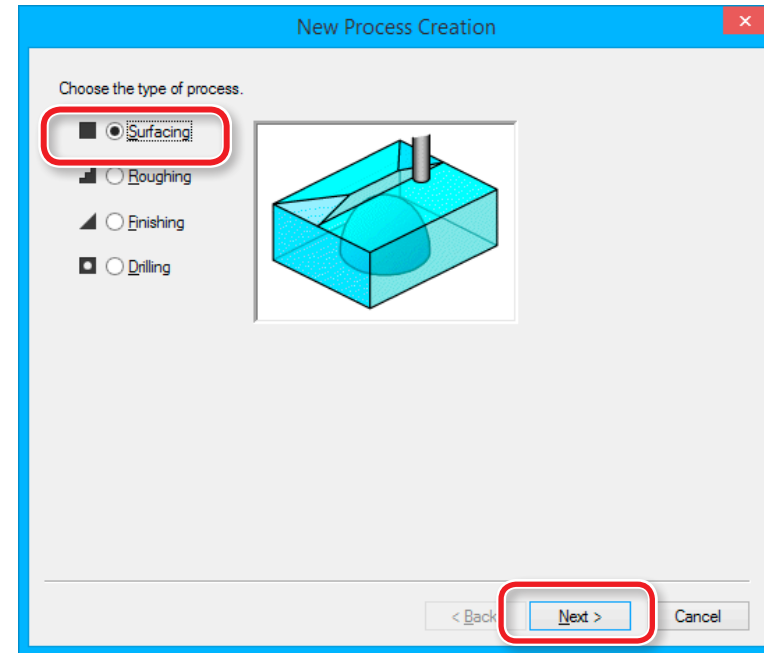



3. Set the cutting surface.

Check that the **[Top [+Z]]** is selected and click the **[Next]**.

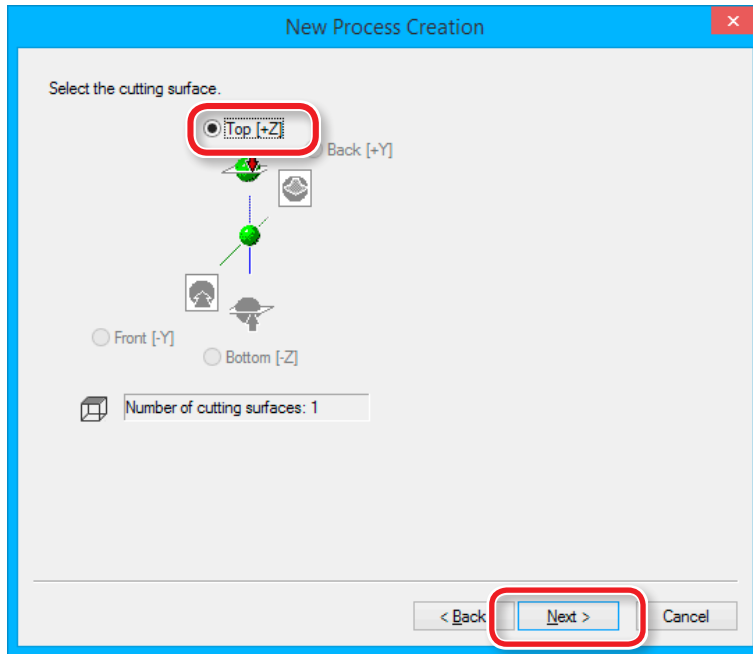

4. Select the cutting tool.

"Piano.stl" : [3 mm Square] → **[Next]**

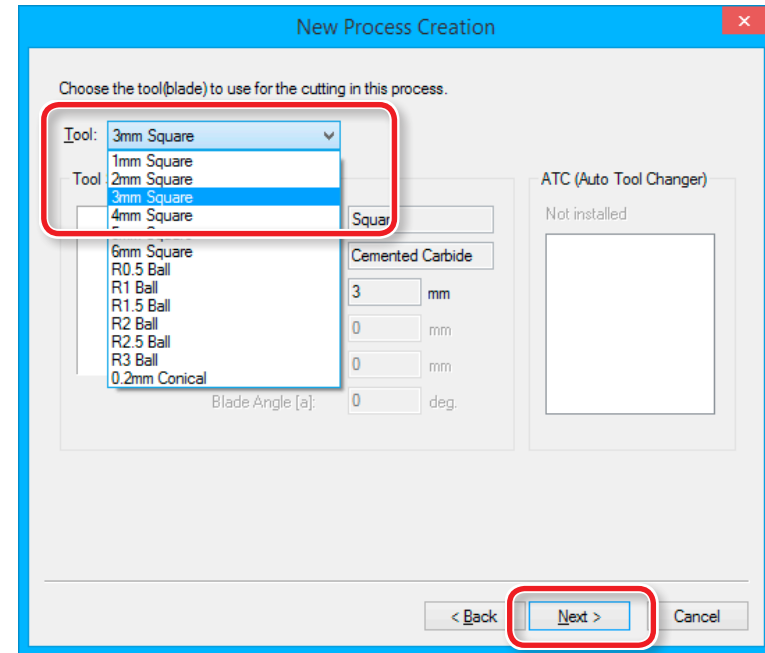

"3 mm Square" is not displayed on the screen

☞ "STEP 2 : Set the Machine Selection" (p. 53)



5. Set the area and depth for surface leveling.

5-1. Set the surface level area.

"Piano.stl" : [Inside modeling form]

5-2. Set the depth of surface leveling.

"Piano.stl" : "0.5" [Set Z0 after surface leveling]

5-3. Click [Next].

Set Z0 after surface leveling

You can set Z0 after surface leveling. When this check box is checked, you don't need to re-set up of origin point after surface leveling.

CAUTION

When the power is turned OFF after surface leveling, the Z origin returns to the setting before the surface leveling. In such a case, re-set up of the Z origin is necessary. If an auto-power-off function has been set, you need to care the power-off time.

☞ "Power Option" (p. 15)

When [Inside modeling form] is selected, the values are automatically entered.



6. Set the tool path.

“Piano.stl” : [Scan Lines] → [Next]

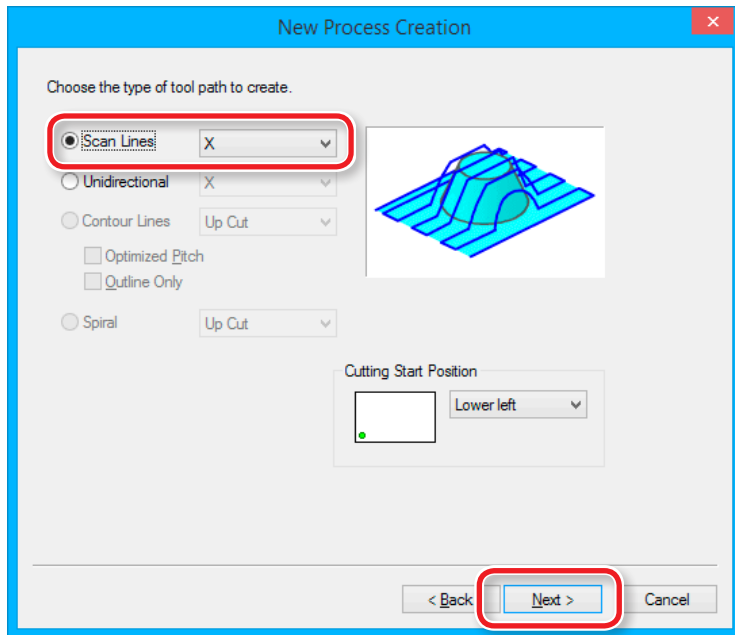

Tool Path

This is the path that is drawn when the cutting tool cuts into the material. Depending on the CAM software used, there are many tool paths for each application.

MODELA Player4 has the following tool paths.

Name	Preview	Feature	Appropriate cutting method
Scan Lines		This creates a tool path parallel to the specified axis. (Parallel with X axis) The path is created in such a way that the outbound movement and return movement lie along the axis.	Surface leveling / Finishing
Uni-directional		This creates a tool path parallel to the specified axis. (Parallel with Y axis) The path is created in such a way that either only the outbound movement or only the return movement lie along the axis.	Surface leveling / Finishing
Contour Lines		This creates a tool path that lies along the contour lines when you're cutting the model into rings on the XY plane.	Roughing / Finishing
Spiral		This creates a spiral tool path.	Finishing



7. Set the cutting parameters.

“Piano.stl” : No change → [Next]



The appropriate conditions are displayed as the initial values from the selected cutting tool settings and material settings. We recommend using the settings as they are (recommended values) except in situations where you want to make a particular adjustment.

The screenshot shows the 'New Process Creation' dialog box with the following parameters:

Parameter	Value	Unit
Material	Chemical Wood (Soft)	
Tool	3mm Square	
XY Speed	12	mm/sec
Z Speed	12	mm/sec
Spindle	7000	rpm
Cutting-in Amount	0.6	mm
Path Interval	1.5	mm
Finish Margin	0	mm
Stay at hole bottom	0	sec

Buttons: < Back, **Next >**, Cancel

8. Enter a name for this process and create the tool path.

“Piano.stl” : [Right Now] → [Finish]

The screenshot shows the 'New Process Creation' dialog box with the following options:

Enter a name for this process and choose whether to create the tool path.

Process Name: Surfacing1

Do you want to create the tool path in addition to the setting? If you don't want to create the tool path now, click [Later].

Right Now
 Later

Buttons: < Back, **Finish**, Cancel



The tool path is created. And the process which is created is displayed.

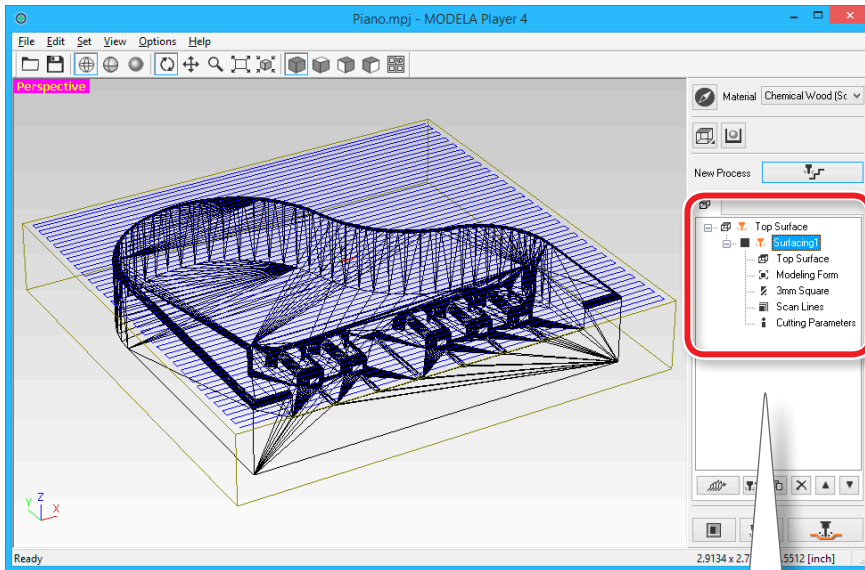

MEMO

A double click of each setting item of a process display a setting screen. The settings can also be changed after the process is created.



STEP 7 : Confirm the Cutting Preview

You can view in 3D and simulate the tool path and cutting tool movement that were set in MODELA Player 4 using the included Virtual MODELA application software.

☞ Download "<http://startup.rolanddg.com>"

Procedure

1. Click  [Cutting Preview].

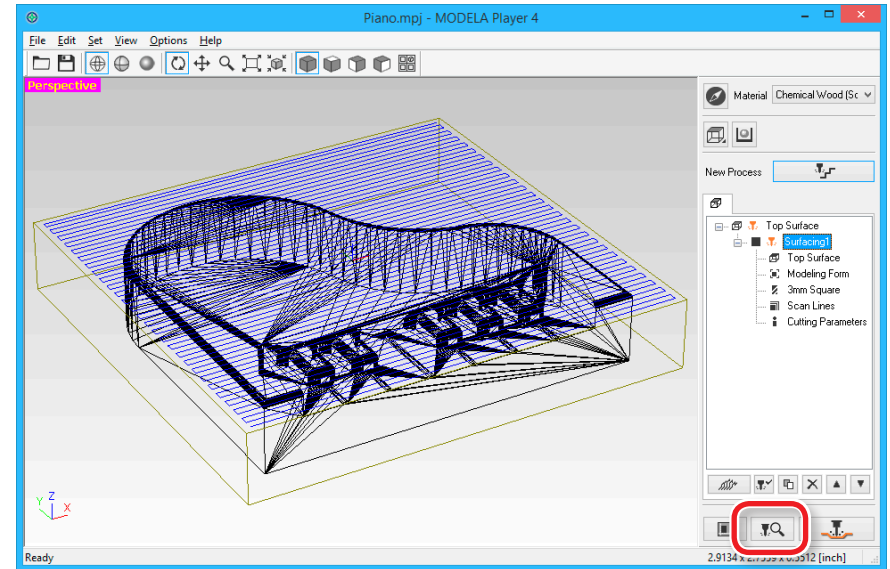



2. When the following screen is displayed, click [OK].

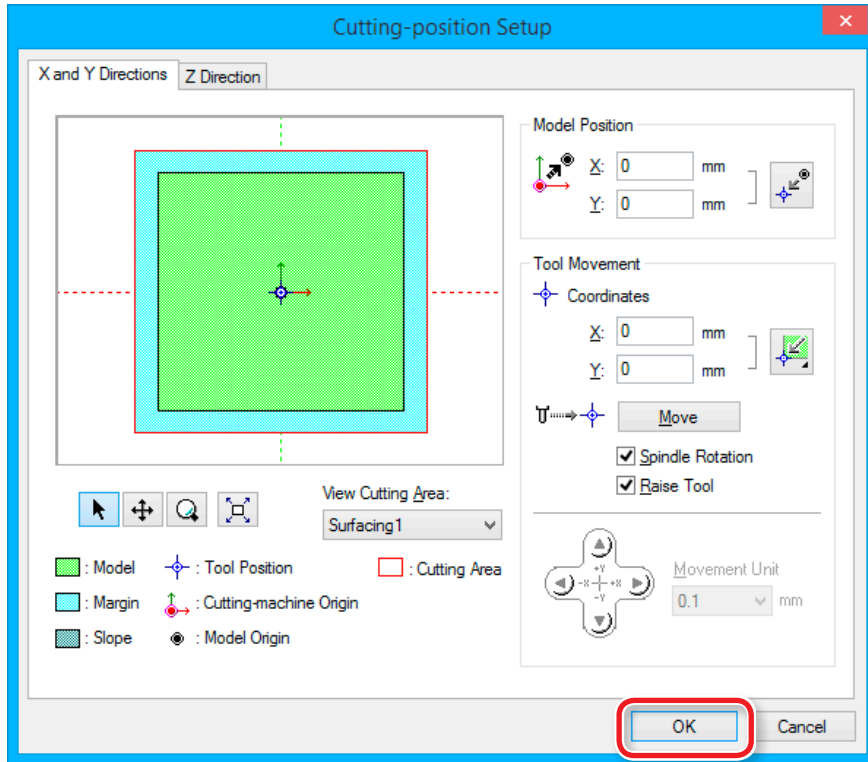

Virtual MODELA starts.

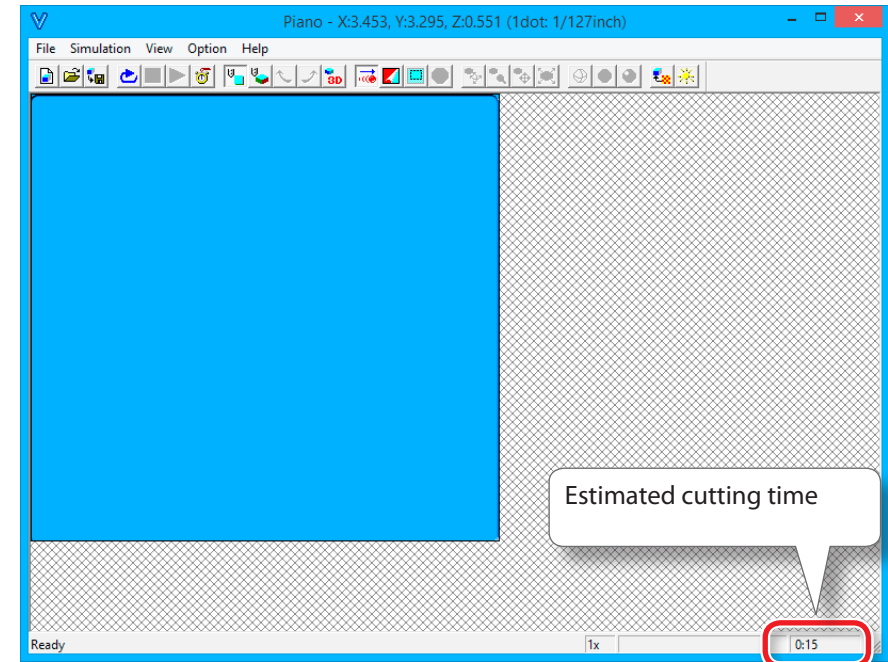

MEMO

For details on the operation methods, please refer to the help.
The help can be displayed with [Help] - [Contents] on the menu.



STEP 8 : Set the Roughing Process

Roughing

This task cuts a rough outline and leaves the detailed portions. This is an important process for reducing cutting time and increasing the efficiency of the finishing process.

Procedure

1. Create the roughing process.

Click  [New Process].

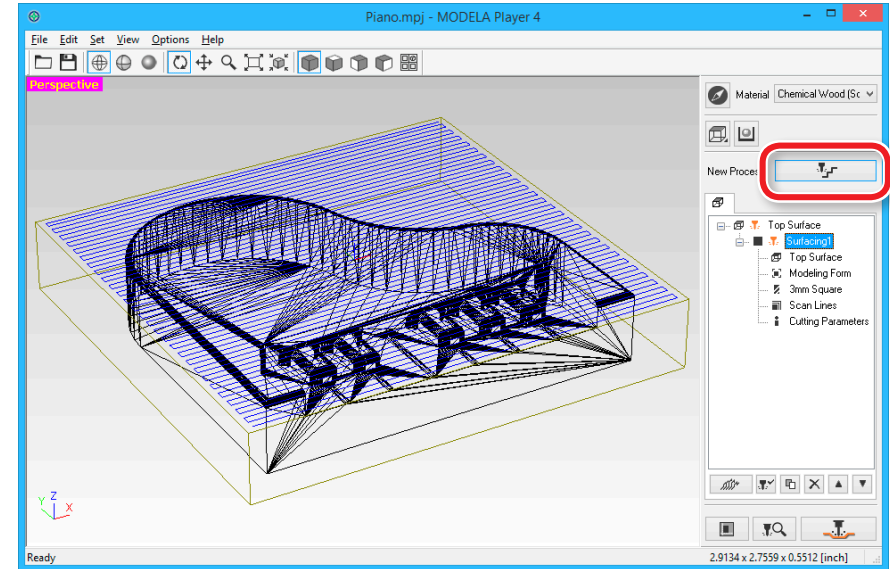



2. Set the type of process.

Select [**Roughing**], then click [**Next**].

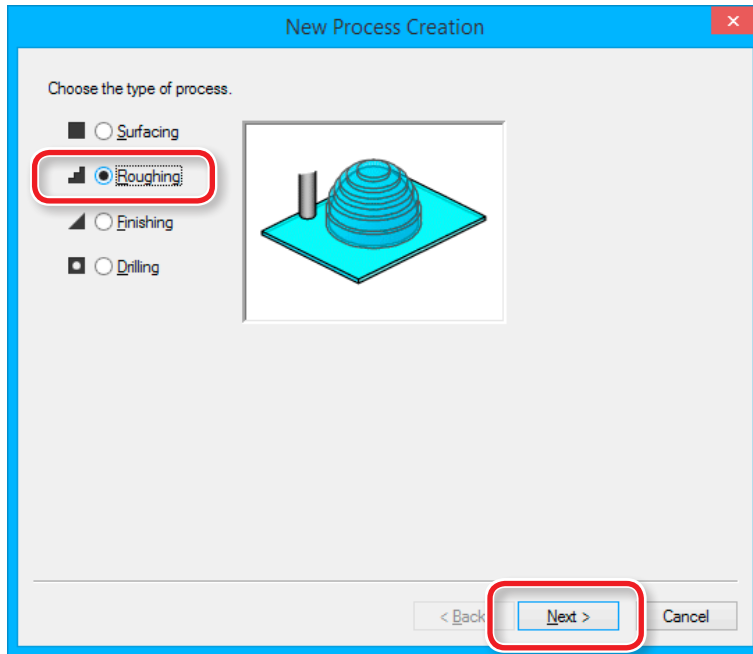

3. Set the cutting surface.

Check that the [**Top[+Z]**] is selected and click the [**Next**].

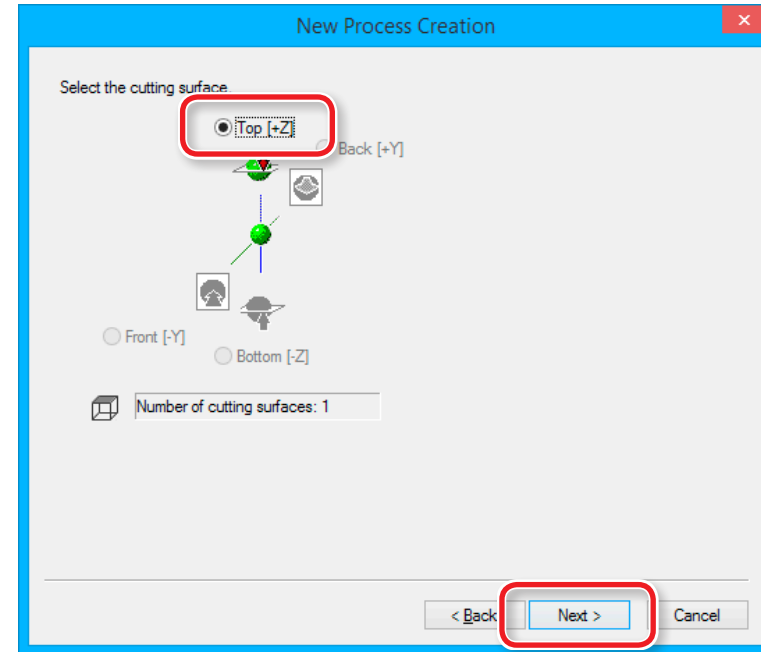



4. Select the cutting tool.

"Piano.stl" : [3 mm Square] → [Next]

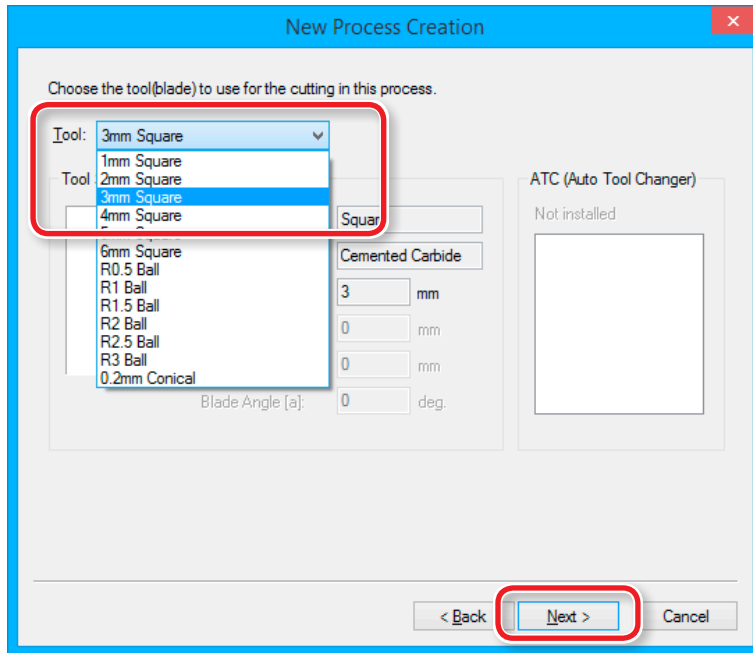

5. Set the area and depth for roughing.

"Piano.stl" : [All] → [Next]

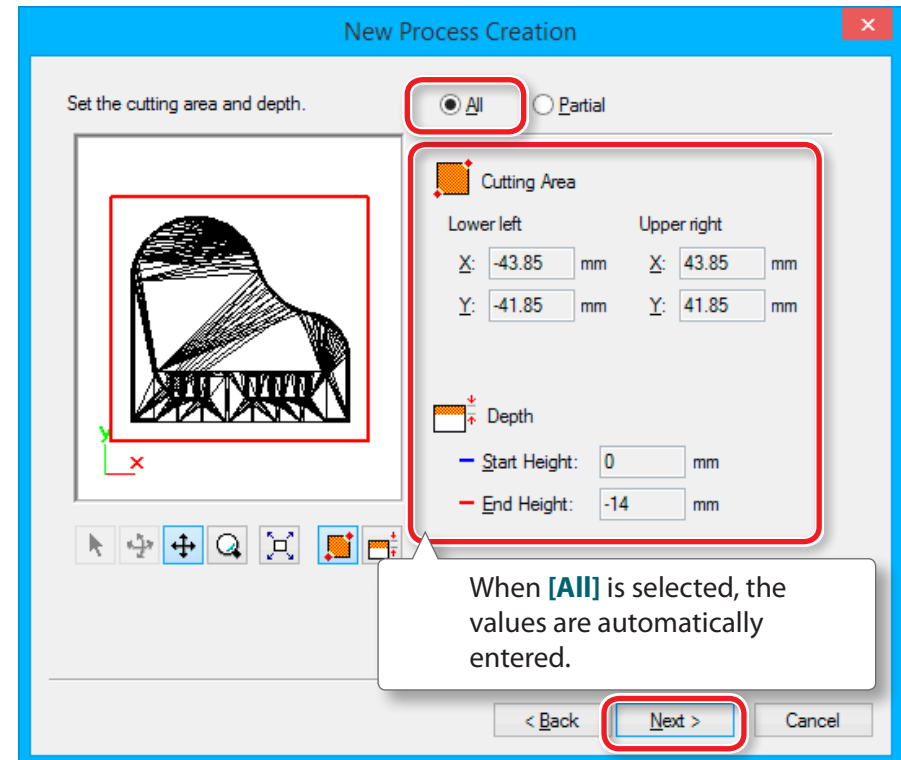



6. Set the tool path.

"Tool Path" (p. 64)

"Piano.stl" : [Contour][Up Cut] → [Next]

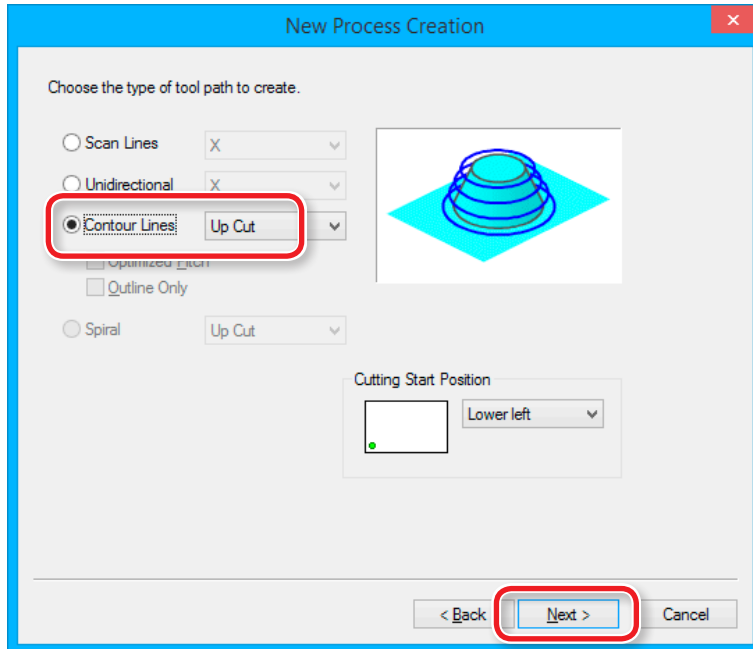

7. Set the cutting parameters.

"Piano.stl" : No Change → [Next]



The appropriate conditions are displayed as the initial values from the selected cutting tool settings and material settings. We recommend using the settings as they are (recommended values) except in situations where you want to make a particular adjustment.

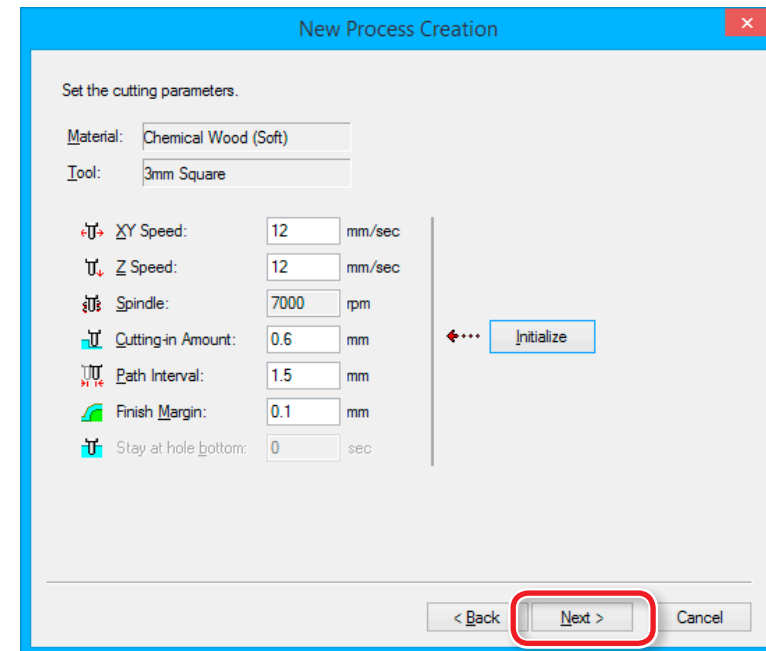



8. Enter a name for this process and create the tool path.

"Piano.stl" : [Right Now] → [Finish]

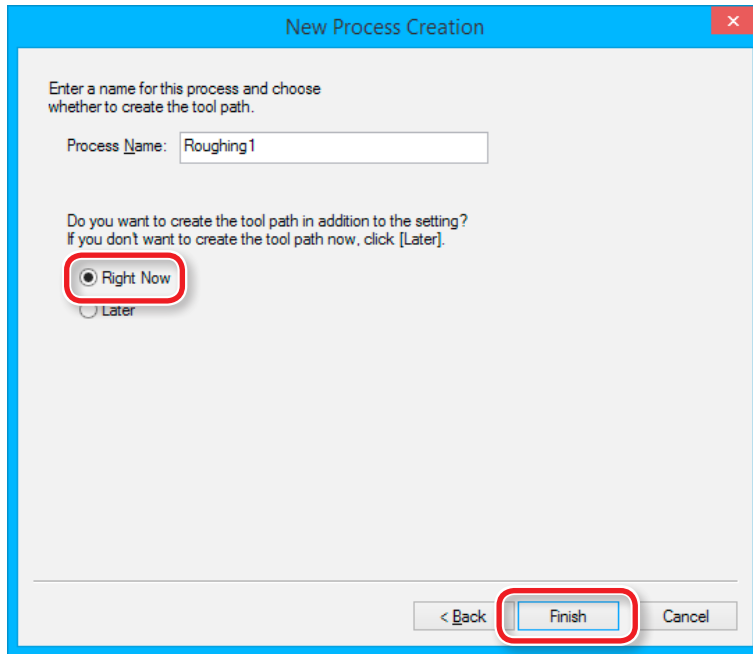

The tool path is created. And the process which is created is displayed.

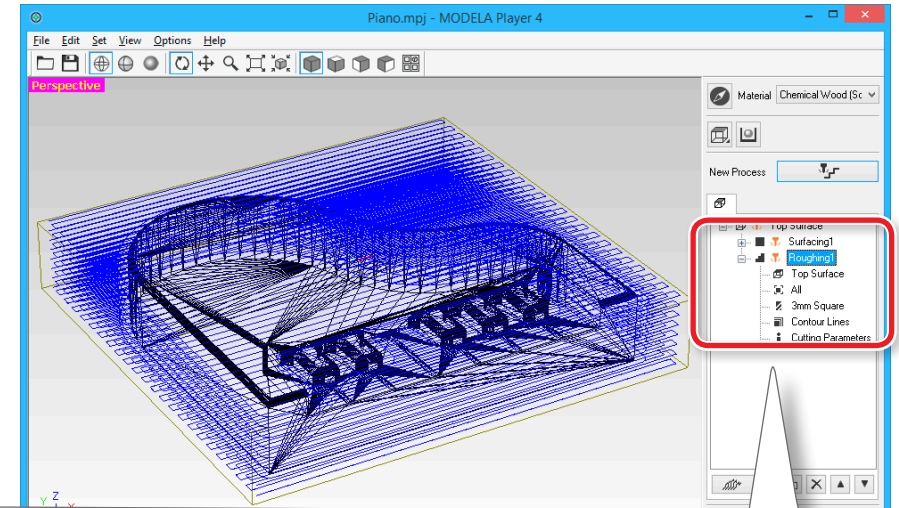

MEMO

A double click of each setting item of a process display a setting screen. The settings can also be changed after the process is created.

9. Check the cutting preview by Virtual MODEL A.

☞ "STEP 7 : Confirm the Cutting Preview" (p. 67)

STEP 9 : Set the Finishing Process

Finishing

The finishing process cuts the finely detailed portions according to the shape of the data. A cleaner finish can be obtained by effectively using the types of cutting tools.

Procedure

1. Create the finishing process.

Click  **[New Process]**.

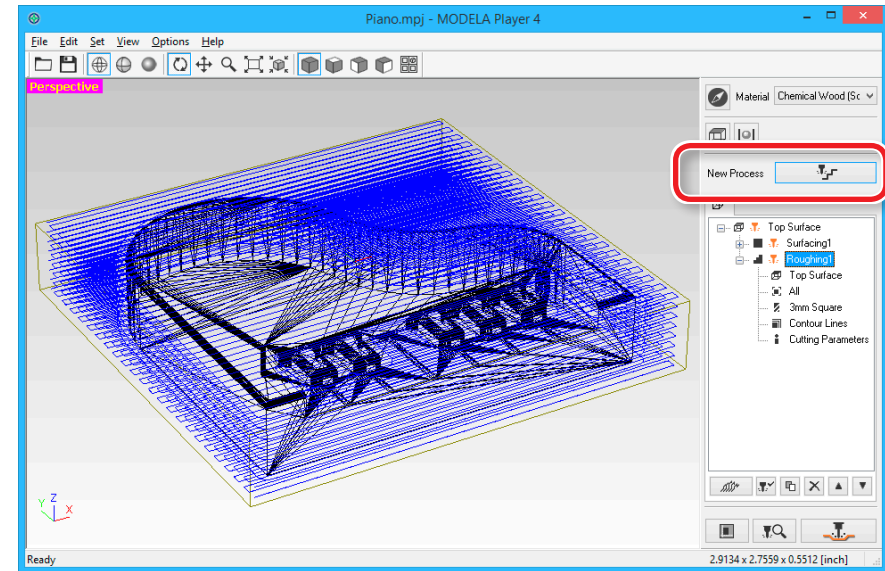



2. Set the type of process.

Select [**Finishing**] and click [**Next**].

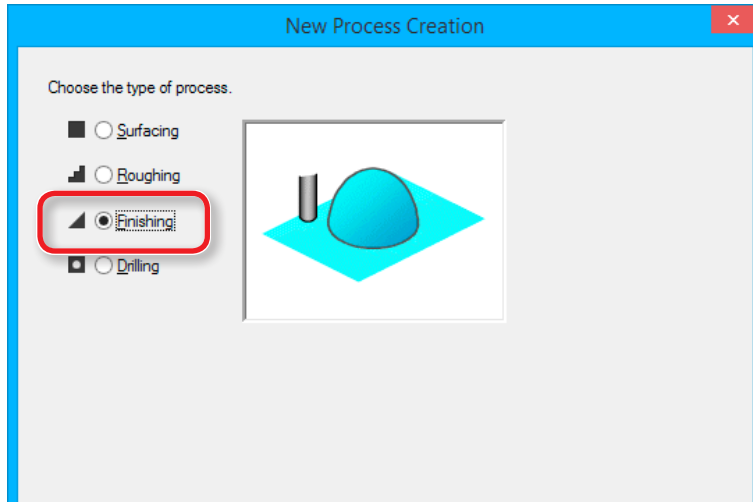

4. Select the cutting tool.

"Piano.stl" : [**3 mm Square**] → [**Next**]

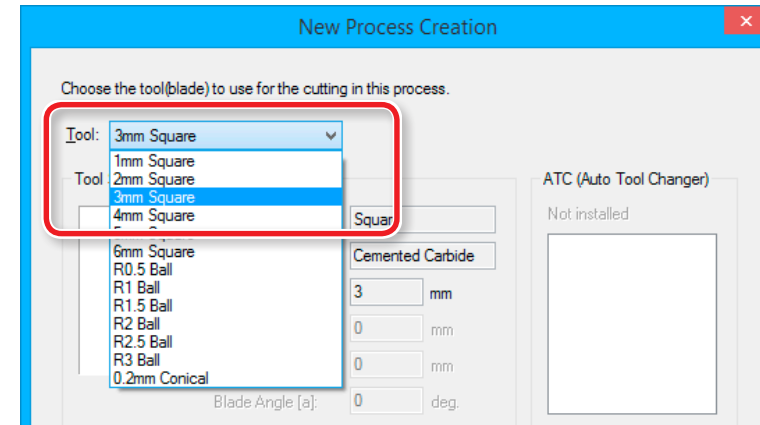

3. Set the cutting surface.

Check that the [**Top [+Z]**] is selected and click the [**Next**].

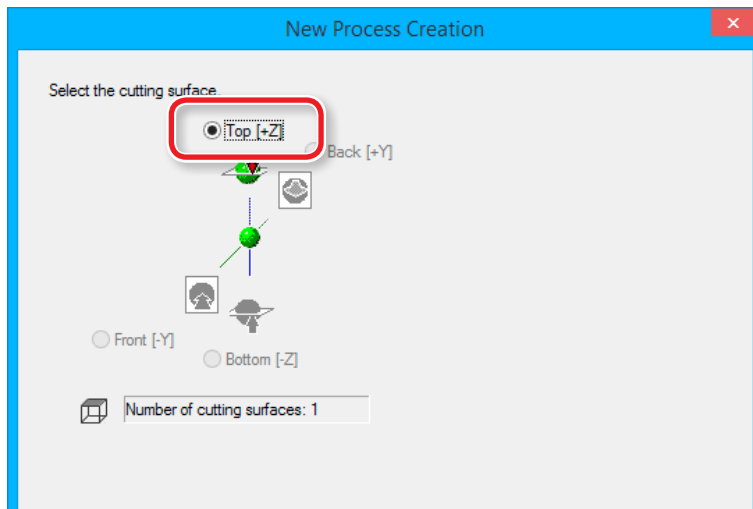



5. Set the area and depth for finishing.

"Piano.stl": [All] → [Next]

When [All] is selected, the values are automatically entered.

6. Set the tool path.

☞ "Tool Path" (p. 64)

"Perfume.stl": [Contour Lines], [Up Cut], [Optimized Pitch] → [Next]

Next >



7. Set the cutting parameters.

“Piano.stl” : No Change → [Next]



The appropriate conditions are displayed as the initial values from the selected cutting tool settings and material settings. We recommend using the settings as they are (recommended values) except in situations where you want to make a particular adjustment.

The screenshot shows the 'New Process Creation' dialog box with the following parameters:

- Material: Chemical Wood (Soft)
- Tool: 3mm Square
- XY Speed: 15 mm/sec
- Z Speed: 15 mm/sec
- Spindle: 7000 rpm
- Cutting-in Amount: 0.1 mm
- Path Interval: 0.1 mm
- Finish Margin: 0 mm
- Stay at hole bottom: 0 sec

An 'Initialize' button is located to the right of the parameter list. At the bottom of the dialog, the 'Next >' button is highlighted with a red circle.

8. Enter a name for this process and create the tool path.

“Piano.stl” : [Right Now] → [Finish]

The screenshot shows the 'New Process Creation' dialog box with the following options:

- Process Name: Finishing1
- Do you want to create the tool path in addition to the setting? If you don't want to create the tool path now, click [Later].
- Radio buttons: Right Now, Later

At the bottom of the dialog, the 'Finish' button is highlighted with a red circle.



The tool path is created. And the process which is created is displayed.

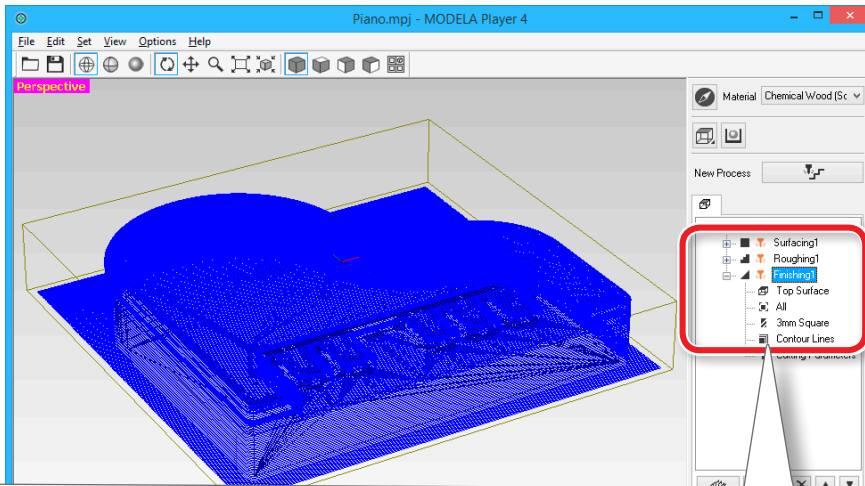

MEMO

A double click of each setting item of a process display a setting screen. The settings can also be changed after the process is created.

9. Check the cutting preview by Virtual MODELA.

☞ "STEP 7 : Confirm the Cutting Preview" (p. 67)

10. Go to "Preparing the Machine" (p. 79).

Save the Created Cutting Data

Click the **[File] - [Save as...]**, you can save the cutting data created by MODELA Player 4. (Extension : mpj)

☞ "The Name and Function of the Main Screen" (p. 13)

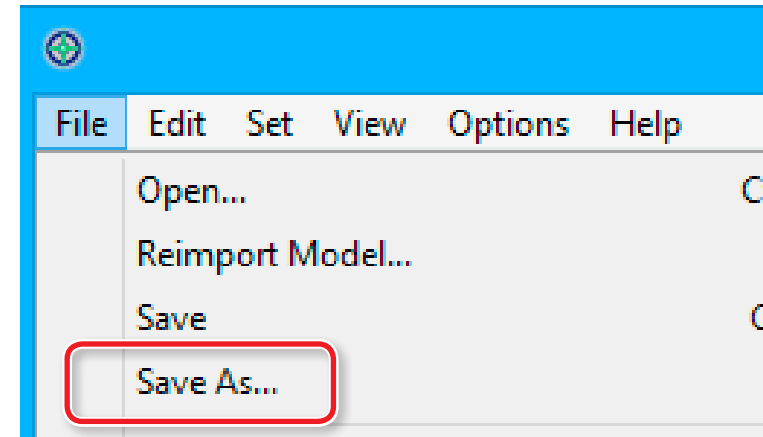

Preparing the Machine

Flow Diagram

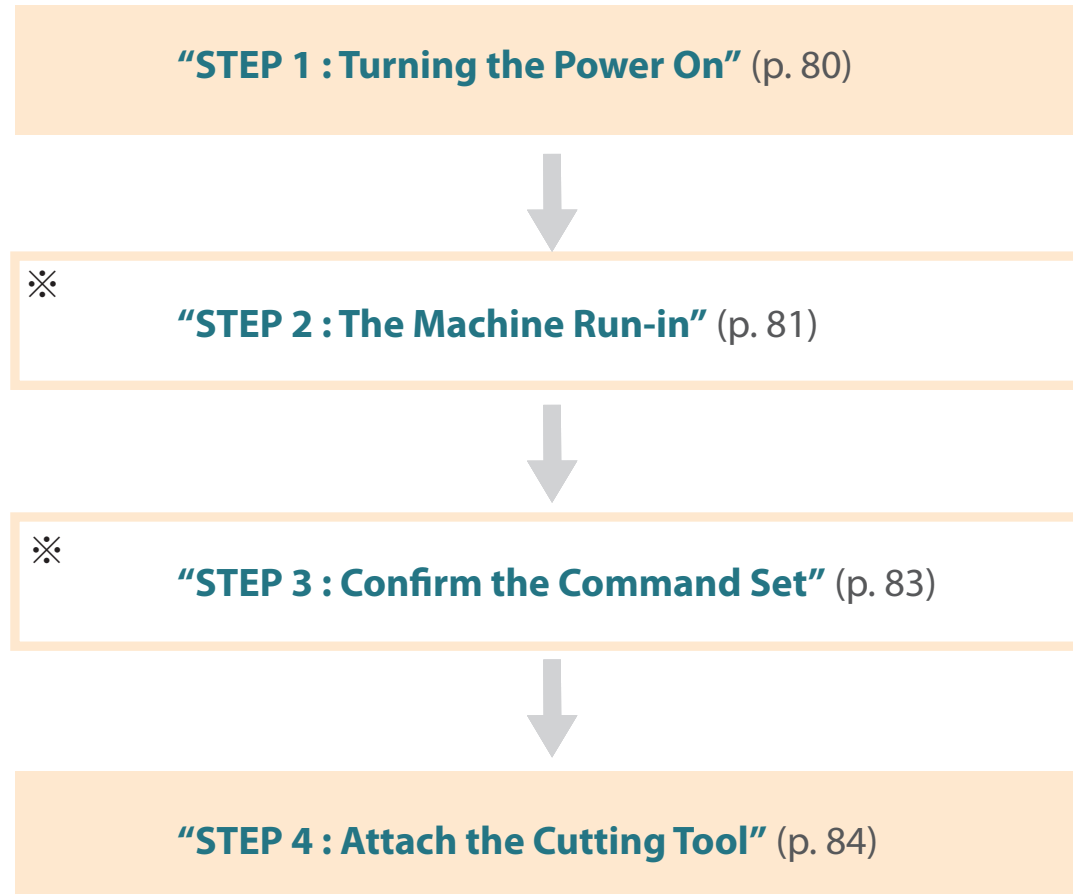

*Work is unnecessary in some cases. For detail, please confirm procedure contents.

STEP 1 : Turning the Power On

Procedure

1. Close the front cover.

2. Press the  (Power) button.

The LED lamp starts flashing and it stays lit after initialization completes.

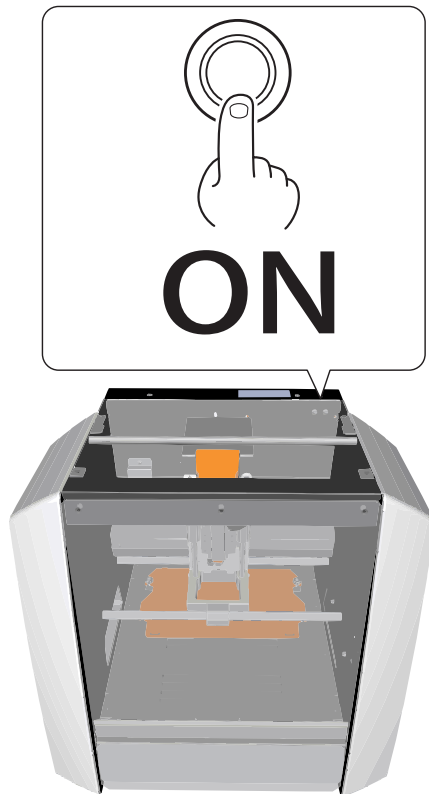

STEP 2 : The Machine Run-in

When the machine must be run-in

- When the machine is first set up
- When the consumable part is replaced
- When the machine is not used for a prolonged period

Go to the **“STEP 3 : Confirm the Command Set”** (p. 83), when the machine does not need to run-in.

Procedure

1. If a material, or cutting tool is mounted on the machine, remove it.
2. Start VPanel.
☞ **“Start VPanel”** (p. 11)
3. Click  at the upper left of a screen, and click **[Maintenance]**.

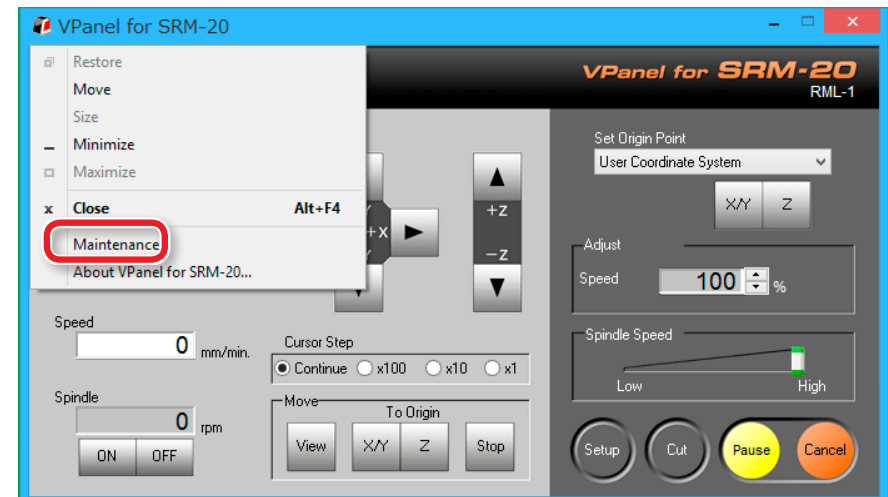



4. Click [Confirm] tab.

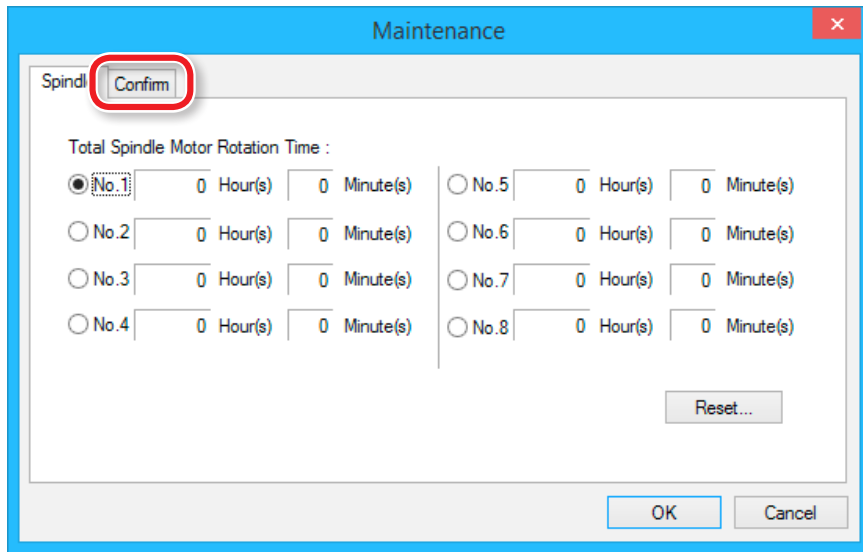

5. Click [Start] of "Idling."

* Required time : Approx. 10 minutes

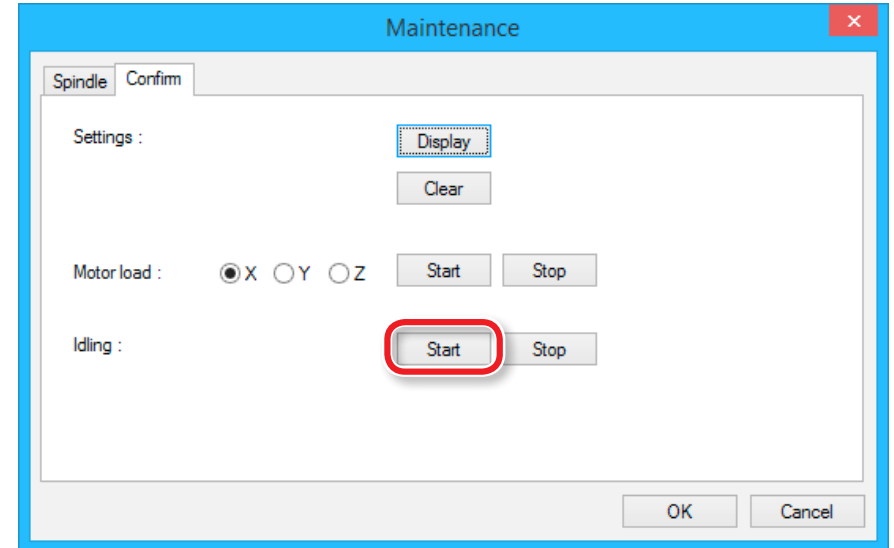

When operation is completed, click [OK] and close a [Maintenance] screen.

STEP 3 : Confirm the Command Set

Select the appropriate command mode to match the software to be used.

☞ “Command Set” (p. 15)

NC Code file outputting

☞ “NC Code Specifications” (p. 111)

CAUTION

If a command that is sent to the machine is different from the command set selected on the VPanel, an error occurs and cutting becomes impossible.

Command Set Setting

Procedure

1. Click [Setup] on the VPanel.

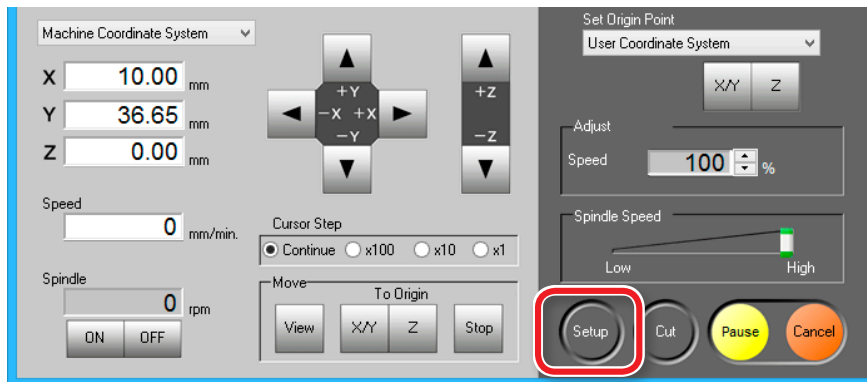

2. Select the suitable command set.

“Piano.stl” : [RML-1] → [OK]

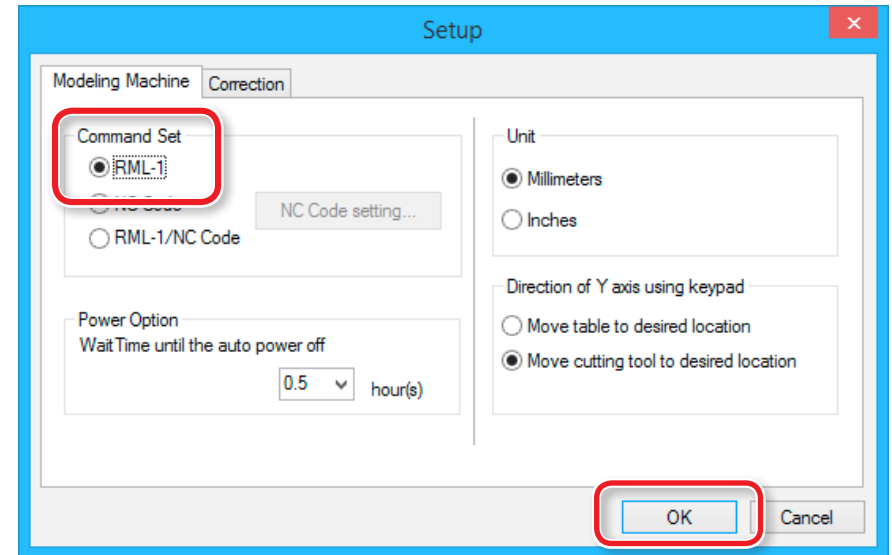

STEP 4 : Attach the Cutting Tool

Select a cutting tool matched to the purpose.

If you use the tools selectively according to the work process such as **“Roughing”** or **“Finishing”** and the design, you can obtain an even cleaner finish. Use a collet that fits the diameter of the cutting tool that will be used.

☞ **“Cutting Tools”** (p. 19)

⚠ CAUTION

Do not touch the tip of the cutting tool with your fingers. Doing so may result in injury.

Procedure

1. Insert a cutting tool in a collet.

Do not insert to the portion of an edge. When you use included cutting tool, refer to the following figure.

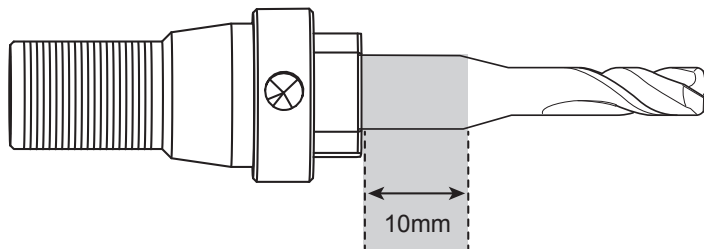

Aim of the cutting tool installation

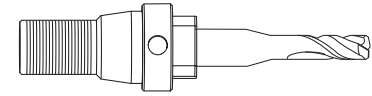

OK

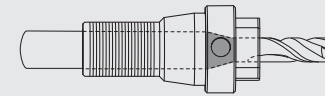

NG

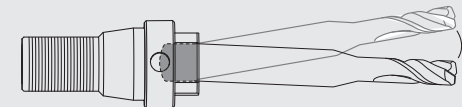

NG



2. Tighten the set screw with hexagonal wrench.

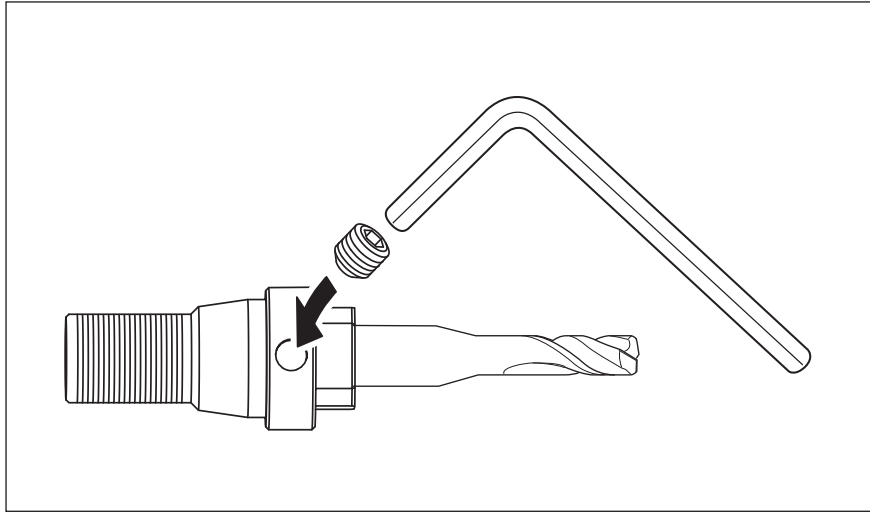

3. Click [View] of VPanel.

A spindle head moves to a center and a table moves to the front.



4. Loosely tighten the collet with cutting tool.

Insert the collet, and then loosely tighten

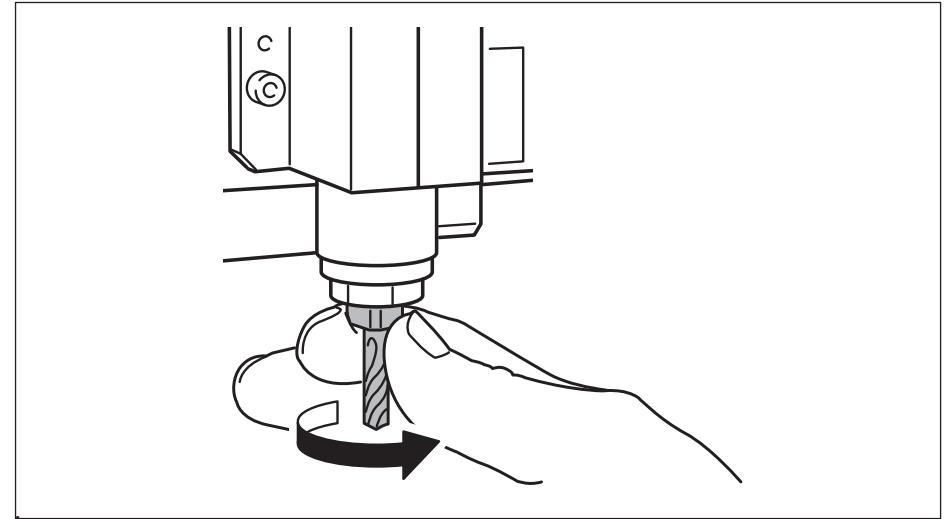

5. Fully tighten the collet.

Tightly secure the collet by using two spanners.

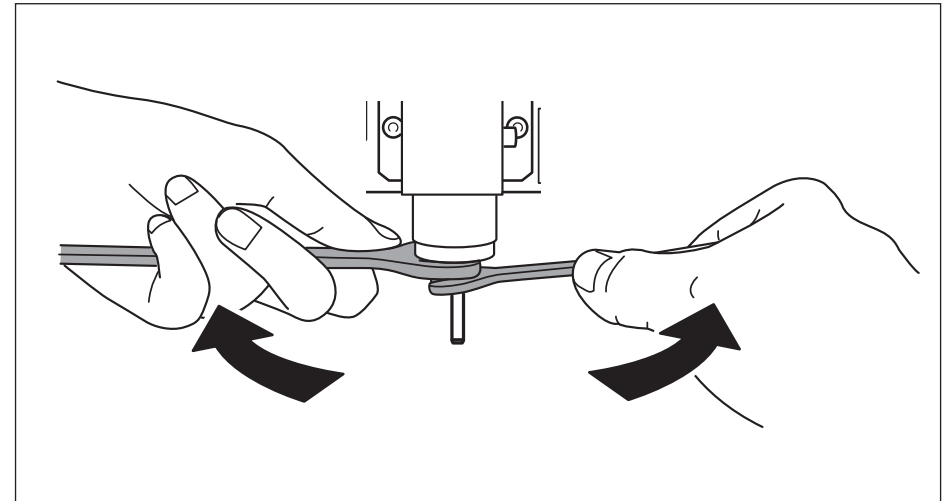



When changing to a cutting tool with the same shank diameter

⚠ CAUTION Do not touch the tip of the cutting tool with your fingers. Doing so may result in injury.

Procedure

- 1. Loosen the set screw with hexagonal wrench.**
Support lightly by hand not to drop a cutting tool.

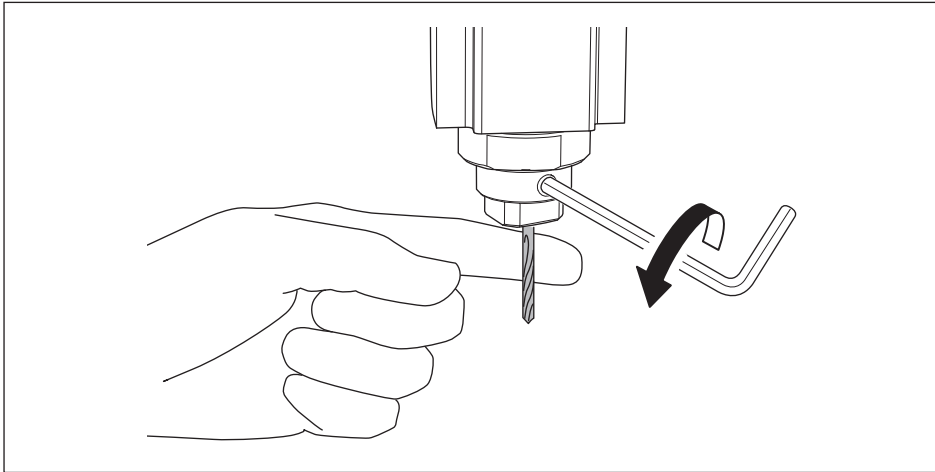

- 2. Remove the cutting tool.**
- 3. Attach the cutting tool which you want to use ,and tighten the set screw.**

When changing to a cutting tool with a different shank diameter

Procedure

- 1. Remove the collet from machine.**
Refer to the procedure 4 to 5 of **“STEP 4 : Attach the Cutting Tool”** (p. 84) in revers order, remove the collet.
- 2. Attach the cutting tool.**
Refer to the procedure of **“STEP 4 : Attach the Cutting Tool”** (p. 84), attach the cutting tool.

Cutting (One Side Cutting)

Flow Diagram

“STEP 1 : Attach the Material to the Table” (p. 88)



“STEP 2 : Set the Origin Point” (p. 89)



“STEP 3: Performing Cutting (when you are using SRP Player)” (p. 93)

“STEP 3: Performing Cutting (when you are using MODELA Player 4)” (p. 100)



“STEP 4 : Remove Processed Material” (p. 102)



“STEP 5 : Turning the Power Off” (p. 103)

“Operations Available during Cutting” (p. 104)

STEP 1 : Attach the Material to the Table

Procedure

1. Mark the location that will be the origin point of the material.

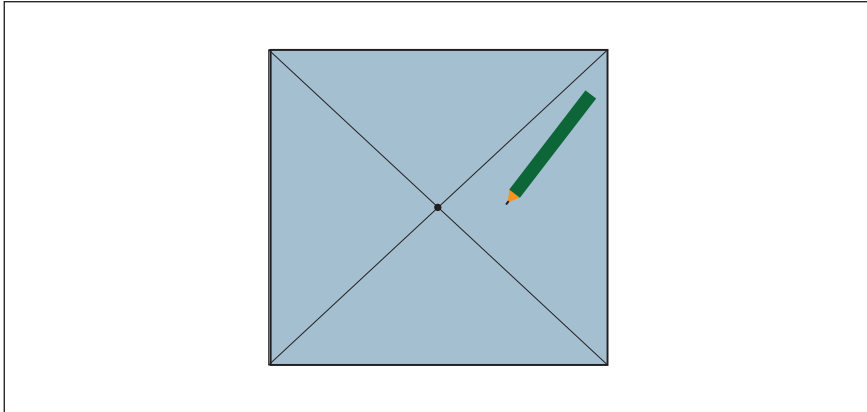

2. Stick double-stick tape on the material.

An adhesion side is made large so that the material may not separate during cutting.

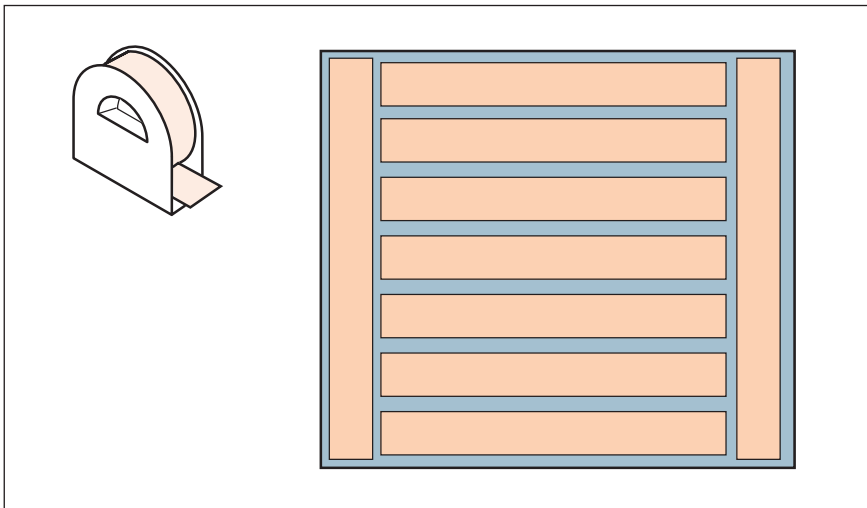

3. Click [View] of VPanel.



4. Attach the material to the table.

MEMO

If you mount it in a position in the front, the work will be easier.

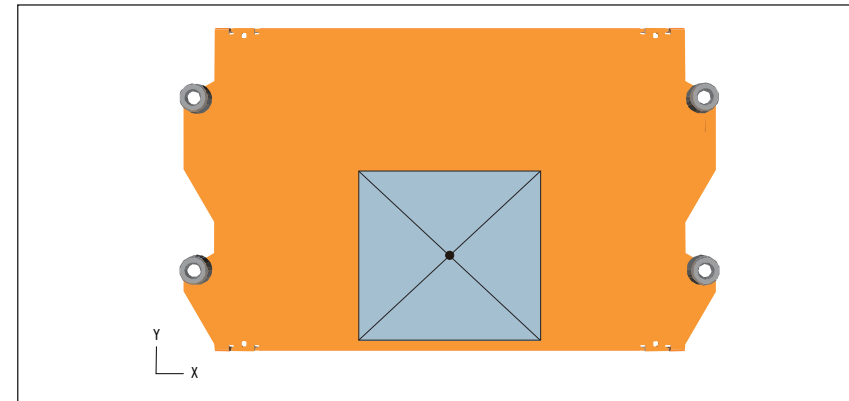

STEP 2 : Set the Origin Point

About Origin Point

Before you start cutting, you must set the origin point.
When you cut with this machine, you need to set the X, Y, and Z origins.

The X and Y origins are determined by the cutting data and the location of the material. (“X” and “Y” cannot be set individually.) You normally align the Z origin with the surface of the material. Take the size of the material and the length of the cutting tool into consideration when you set the origins.

In addition, the locations that you should specify for the origins vary depending on the application software that you are using. Set up depending on the specification of the application software that you are using.

- ☞ SRP Player : “Origin point of the Model / Origin point” (p. 96)
- ☞ MODELA Player 4 : “Origin point of the Model / Origin point” (p. 54)

1. Prepare to set the origin point

1. Select [Machine Coordinate System] on the VPanel.

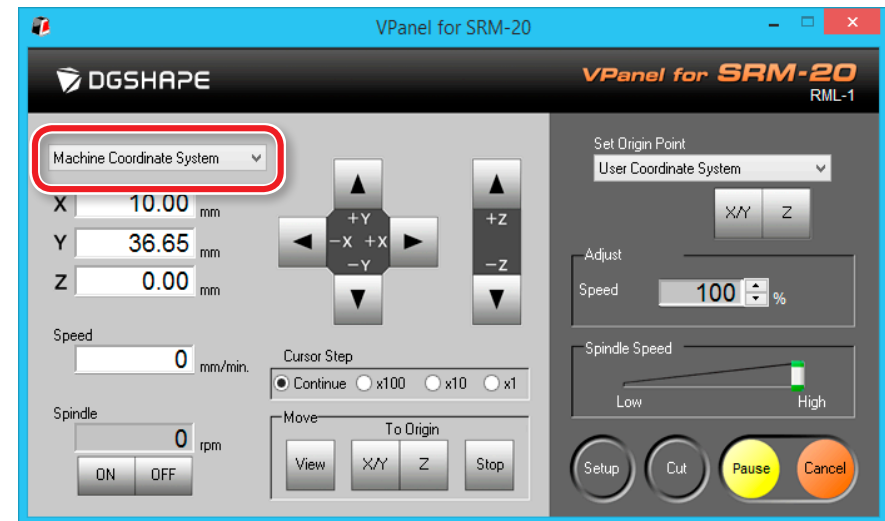

2. Click [X/Y][Z] of [Origin] in [Move].





3. Check that XYZ is "0.00 mm."

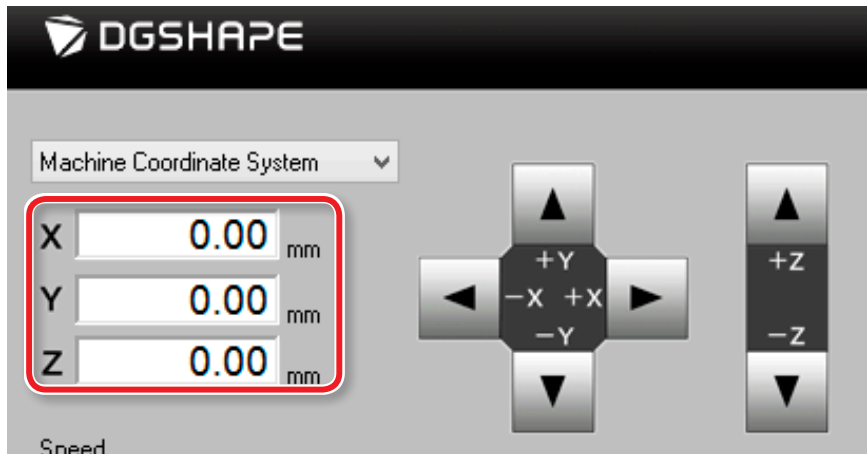

4. Select [User Coordinate System], check that XYZ is "0.00 mm."

If "0.00 mm" does not appear for X, Y and Z, click [X/Y], then [Z] under set origin point.

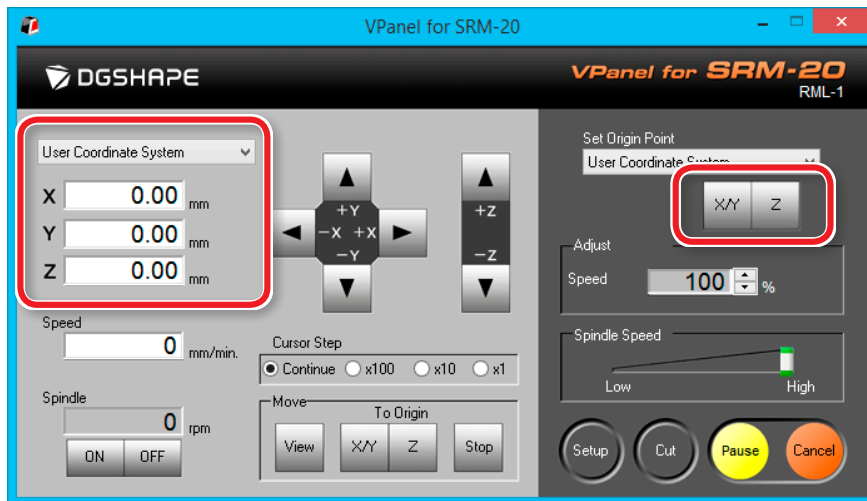

2. Set the origin point

1. Click [X][Y] cursor button, move right above the origin point which put the mark by STEP1.

☞ "Direction of Y axis using keypad" (p. 15)

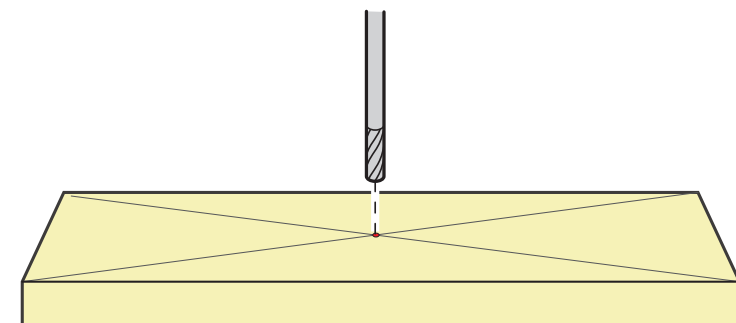
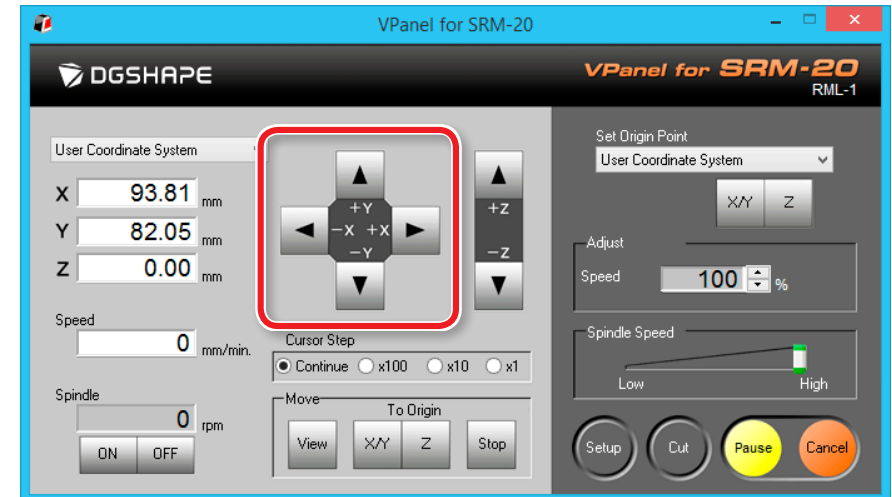



2. Click the [- Z] cursor button to approximate the tip of the cutting tool to the surface of the material as much as possible.

The hole of the mounting screw must be seen (to loosen the set screw with the hexagonal wrench).

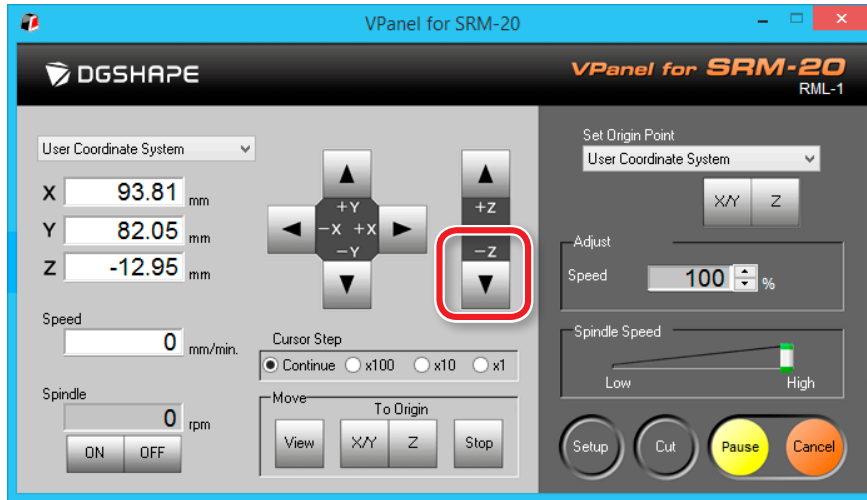

3. Loosen the set screw, and then adjust the cutting tool so that its tip contacts the surface of the material.

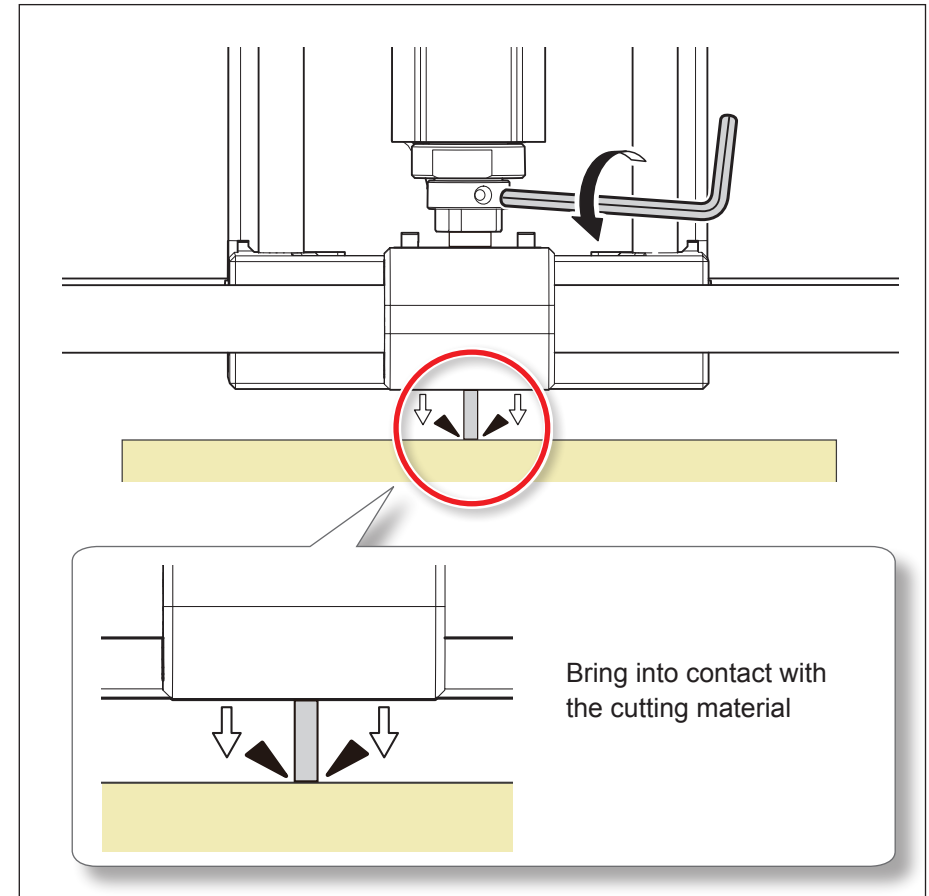



4. Tighten the cutting tool in place again with the set screw.

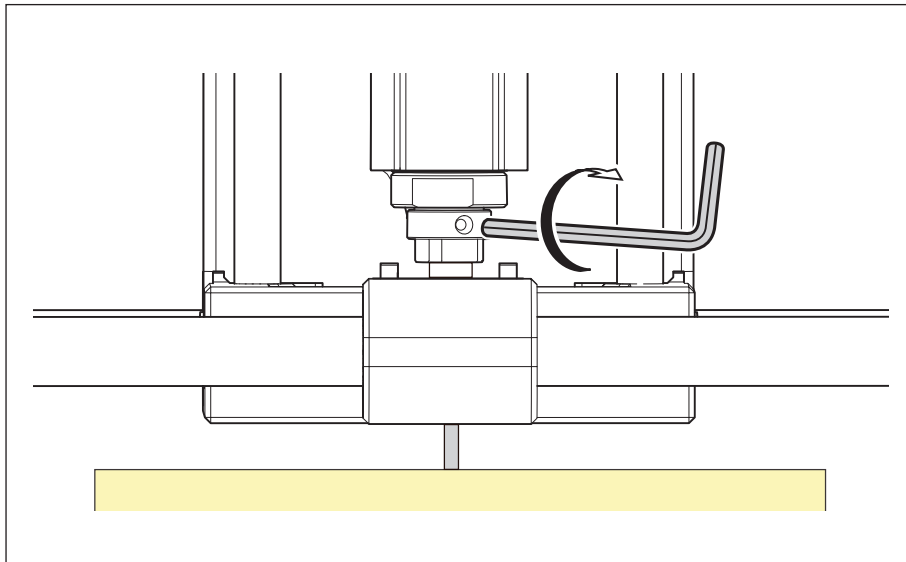

5. Click [X/Y][Z] of set origin point.



6. Click [YES].

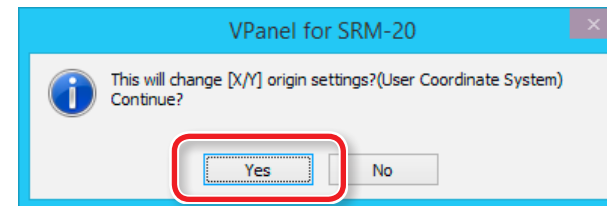

7. Confirm that the coordinates have all become "0."

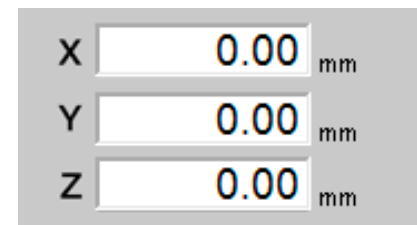

STEP 3: Performing Cutting (when you are using SRP Player)

MEMO

If you are using MODELA Player 4 rather than SRP Player, proceed to **“STEP 3: Performing Cutting (when you are using MODELA Player 4)”**

☞ **“STEP 3: Performing Cutting (when you are using MODELA Player 4)”**
(p. 100)

MEMO

During cutting, you can adjust the cutting tool movement speed or the spindle speed.

You can also pause/resume or cancel the cutting.

☞ **“Pausing / Resuming”** (p. 104)

☞ **“Cancel the Cutting”** (p. 105)

☞ **“Caution of Cutting After an Emergency Stop and a Shutdown”**
(p. 105)

☞ **“Adjusting the Feed Rate and Spindle Speed During Cutting”**
(p. 106)

The points to be checked before cutting

Check the following thing before starting cutting. If there are problems with any of these, the cutting material may be wasted or the machine may be damaged.

- Is an output file right?
- Have you made a mistake with the origin point position?
- Do the cutting conditions match the type of cutting material?

Leveling the Material Surface

Procedure

- 1.** On the menu bar of SRP Player, click **[Options]** → **[Surfacing...]**.



2. On the dialog that appears, configure leveling cutting range, depth, and other settings.

This example assumes that the following options are configured:

- Material : Chemical Wood (Soft)
- Tool : 3 mm Square
- Orbit Direction : Up Cut
- Depth : 1.00 mm
- X : 100.00 mm
- Y : 100.00 mm

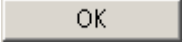
When you are done, click .

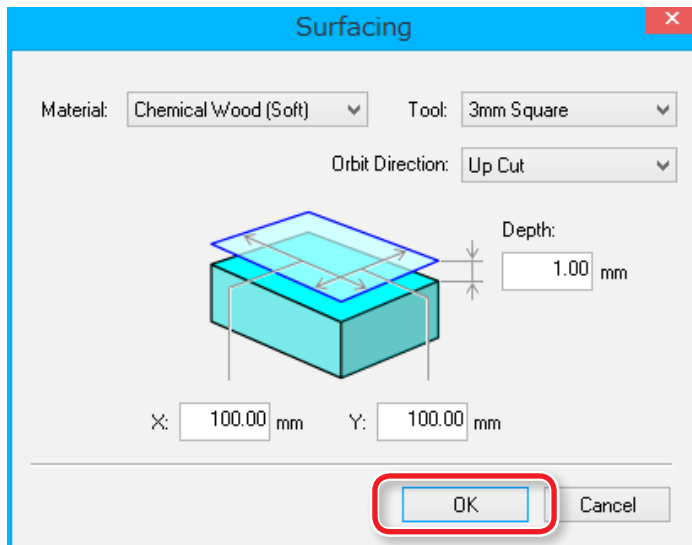

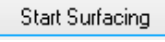
3. Make sure that the desired tool and origin position are correctly set up and then click .

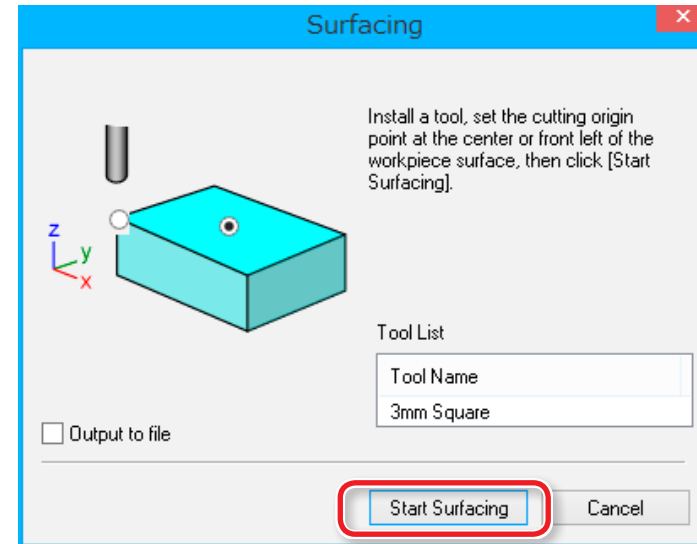

IMPORTANT

Before starting the cutting processes, double-check that the origin point exists on the top surface of the material.
If the origin point is incorrectly positioned, the machine may fail to cut the workpiece as expected or break down.



Performing Cutting

Procedure

1. Open the **Perform Cutting** pallet.
2. Click **Start Cutting...**.

Perform Cutting

Output the cutting data to the cutting machine and start cutting.

Start Cutting...

(Tool changing or other instructions may be displayed during milling. Please follow instructions when instructed to do so.)

Output to file

Tool List

Tool Name	L
3mm Square	15

3. Check if the cutting tool is installed as shown in the dialog and then click **Next >**.

Cutting

Install the following tool in the spindle.

(As shown in the figure, make the tool extend farther than length L.)

Tool Name	L
3mm Square	15

When you're done, click [Next].

< Back **Next >** Cancel



4. Select the surface of the material and then click .

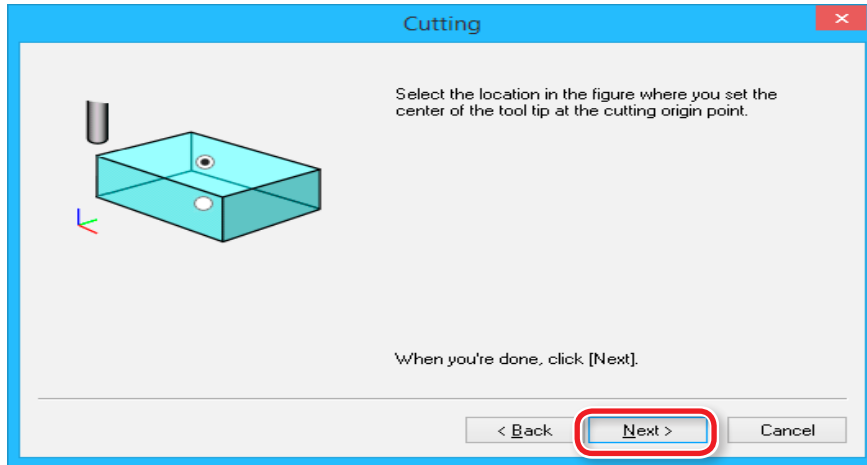

IMPORTANT

Before starting the cutting processes, double-check that the origin point exists on the top surface of the material.
If the origin point is incorrectly positioned, the machine may fail to cut the workpiece as expected or break down.

Origin point of the Model / Origin point

- Origin point of the model : XY origin point set up on cutting data
(The origin point on the data of SRP Player)
- Origin point : XY origin point set up on the machine
(Can be set anywhere in the cutting area)

Relation between the origin point of the model and the origin point

Set up the origin point of the model and the origin point of the machine to become the same position.

Origin point : Center
Origin point of the model : Center

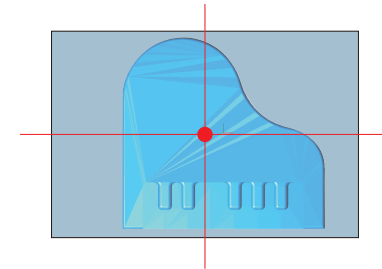

OK

Origin point : Lower left
Origin point of the model : Center

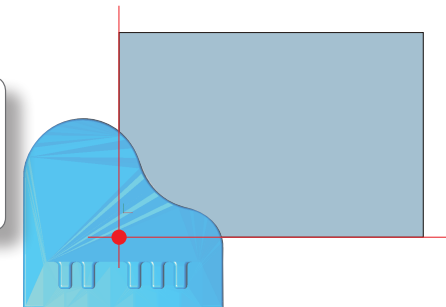

NG



5. Click **Next >**.

The machine begins cutting.

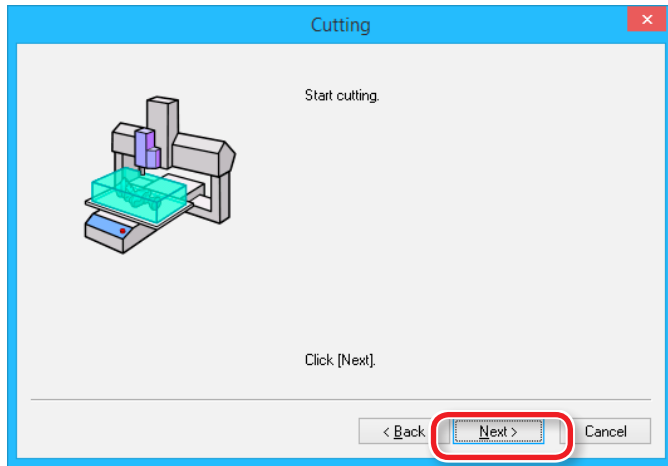

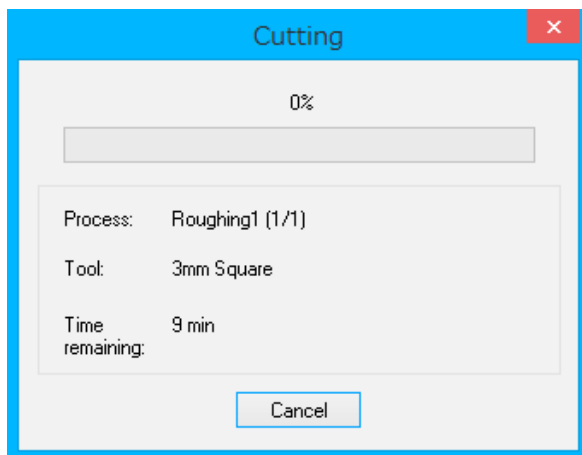

A dialog appears that shows what is being output and the progress of machining.



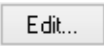

Cutting Only the Selected Process

Procedure

1. Open  Create Tool Path pallet.
2. Click  .
3. Click the process you do not need.
4. Click  [Enable/Disable Cutting].
5. Repeat steps 3 and 4 to disable all the unnecessary processes.

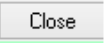

Only the colored processes  will be output.

6. Click  .
7. Start the cutting process using the same procedure as for the normal cutting process.

☞ **“Performing Cutting”** (p. 95)

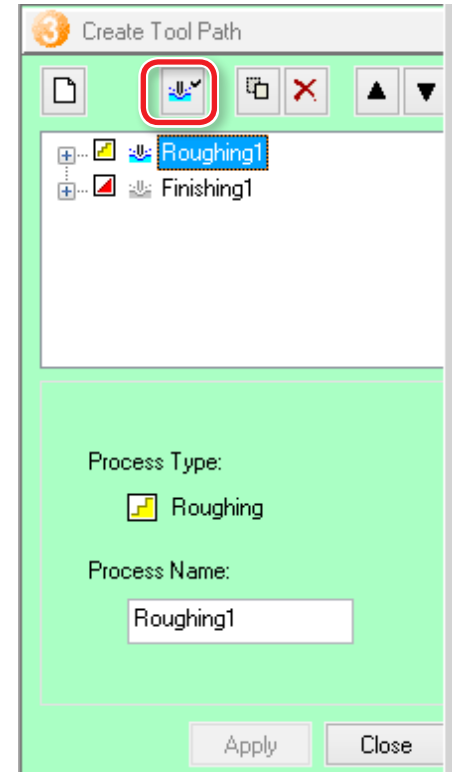



Completing Cutting

Click .

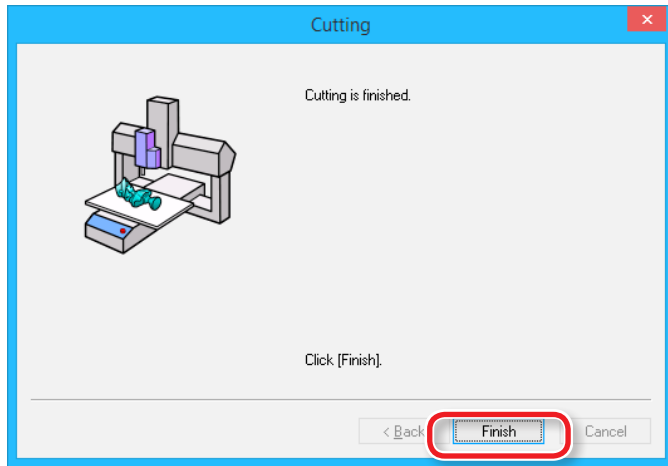

STEP 3: Performing Cutting (when you are using MODELA Player 4)

MEMO

If you are using SRP Player rather than MODELA Player 4, proceed to **“STEP 3: Performing Cutting (when you are using SRP Player).”**

☞ **“STEP 3: Performing Cutting (when you are using SRP Player)”** (p. 93)

MEMO

During cutting, you can adjust the cutting tool movement speed or the spindle speed.

You can also pause/resume or cancel the cutting.

☞ **“Pausing / Resuming”** (p. 104)

☞ **“Cancel the Cutting”** (p. 105)

☞ **“Caution of Cutting After an Emergency Stop and a Shutdown”** (p. 105)

☞ **“Adjusting the Feed Rate and Spindle Speed During Cutting”** (p. 106)

When “Cutting Position Setup” is displayed

If you have not performed a cutting preview in Virtual MODELA, **“Cutting-position Setup”** is displayed. Then Click **“OK.”**

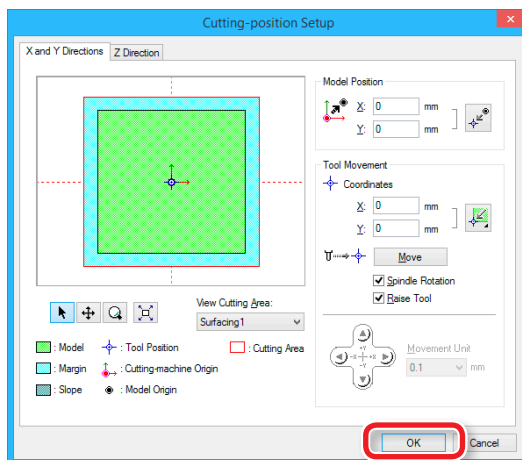

The points to be checked before cutting

Check the following thing before starting cutting. If there are problems with any of these, the cutting material may be wasted or the machine may be damaged.

- Is an output file right?
- Have you made a mistake with the origin point position?
- Do the cutting conditions match the type of cutting material?

Procedure

1. Click  **[Cutting]** of MODELA Player 4.

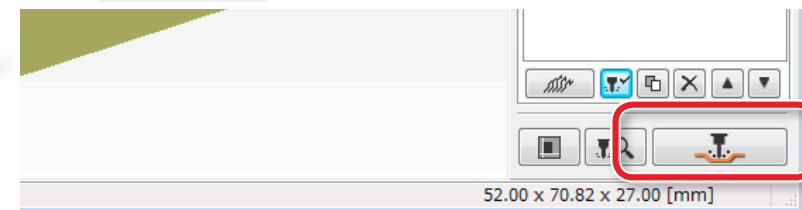



2. Click [OK].

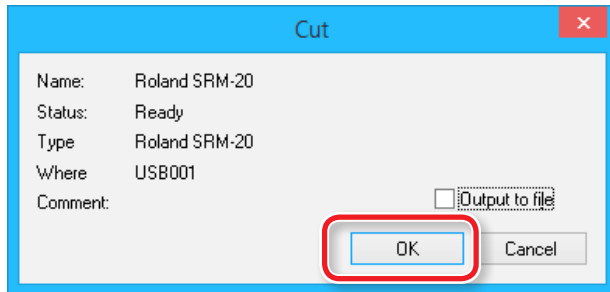

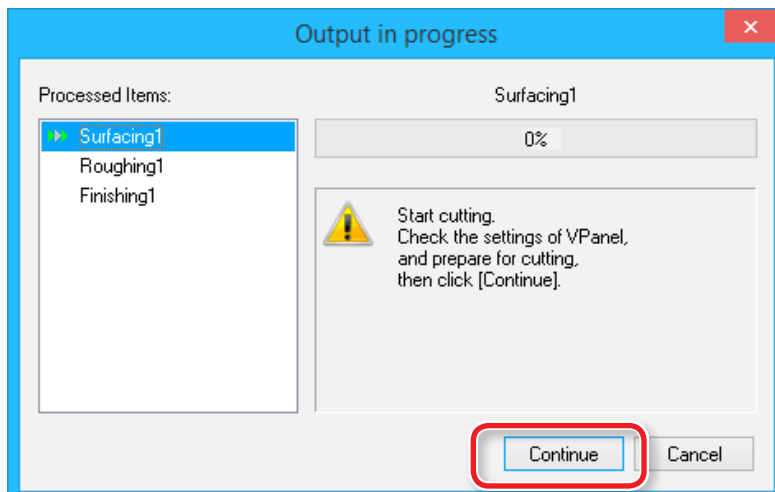

3. Click [Continue].

In the "Processed items," outputting contents is displayed.



Cutting Only the Selected Process

Select the unnecessary process and click  [Enable/Disable Cutting].

 Only the orange-colored processes  will be output.

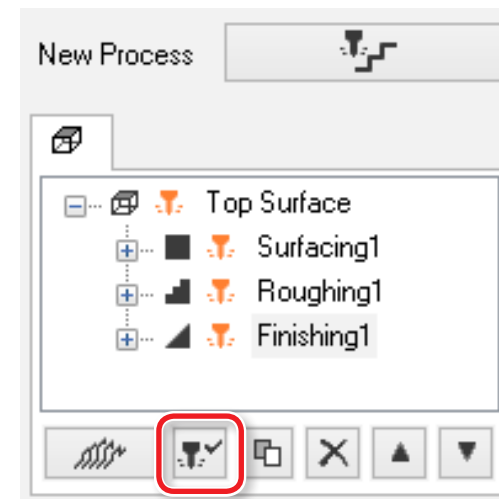

STEP 4 : Remove Processed Material

MEMO

Depending on the settings configured on VPanel, the power may automatically turn off when a certain period of time elapses with the machine idle*.

* **“Idle”** means the state in which the movement of the table and spindle head is stopped (except when a cutting process is paused).

☞ **“Power Option”** (p. 15)

1. Click [View] of VPanel.



2. Remove the cutting waste and the material.

Remove the double-stick tape on the back of the material.



When material cannot remove finely, it removes using wooden spatulas etc.



The piano can be cut out by making the depth of the cutting deeper than the cutting data. (* A scrap board is necessary. **“Scrap Boards”** (p. 20))

When combined with the piano legs data (**“Sample Cutting Data”** for MODEL A Player 4 (p. 27) - **“Piano_leg.stl”**), the result looks like the figure below.



STEP 5 : Turning the Power Off

Push [⏻] (Power) button.

A LED lamp lights off. After cutting, clean the cutting waste certainly.

☞ **“Cleaning after Cutting Operation Ends”** (p. 119)

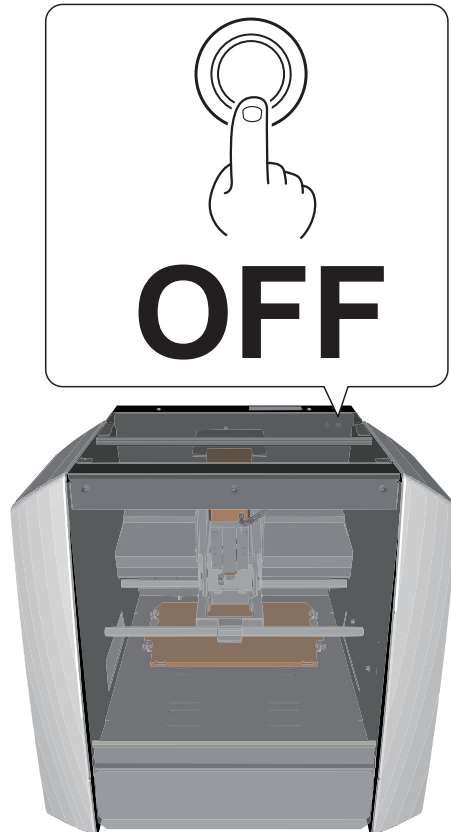



Operations Available during Cutting

Pausing / Resuming

Click **[Pause]** of VPanel. The display of a button changes to **[RESUME]**. Click **[RESUME]** to resume.

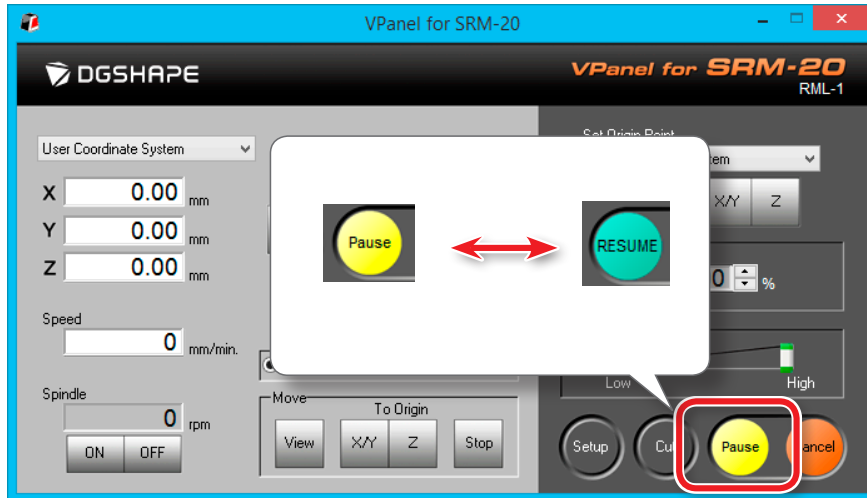

Cleaning during an extensive cutting operation (X,Z-axis)

If cutting waste accumulates during an extensive cutting operation, the machine's operation may be hindered, resulting in a product that does not meet expectations. Keep an eye on how much cutting waste builds up and pause the machine to remove the cutting waste that has built up around the X- and Z-axes before the movement worsens. Also remove the cutting waste of a dust tray.

 If you **[Pause]** when the cutting tool is not touching the material, traces of cutting will be less likely to remain on the material.



Cancel the Cutting

When you want to cancel the cutting, click the **[Cancel]** of VPanel. Outputting data is deleted .

☞ **“It Takes Time to Delete Data After Quitting Cutting”** (p. 130)



Caution of Cutting After an Emergency Stop and a Shutdown

If an emergency stop or an emergency shutdown occurs during cutting, remove the cutting tool and the material from the machine. When the operation resumes, initialization is performed on the machine. At this time, the cutting tool and the material may collide depending on the position in which the tool and workpiece stopped, which can cause damage to the machine while restarting.

☞ **“Responding to Error Messages”** (p. 144)



Adjusting the Feed Rate and Spindle Speed During Cutting

The feeding speed and number of rotations of a spindle can be adjusted during cutting by VPanel.



Adjusting Cutting Speed (Override)

This works for the speed of cutting tool movement when cutting the workpiece. The speed specified by the command in the cutting data is taken to be 100%.

Adjusting Rotation Speed of the Spindle

This works for the rotation speed of the spindle. Move the slider to set the speed between **“Low”** and **“High.”**



* The speed cannot be specified from any application other than VPanel.

NC Code

NC Code Setting	108
NC Code Setting Dialog	108
Test Cut Dialog in NC Code	110
NC Code Specifications.....	111
List of Settings Related to NC Code.....	111
Items Related to the Mechanical Specifications	112
Interpretations of NC Code Omissions	113
Word List.....	115

NC Code Setting

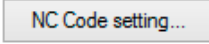
NC Code Setting Dialog

This dialog is displayed when  in  Settings is clicked on the VPanel.

NC Code Tab

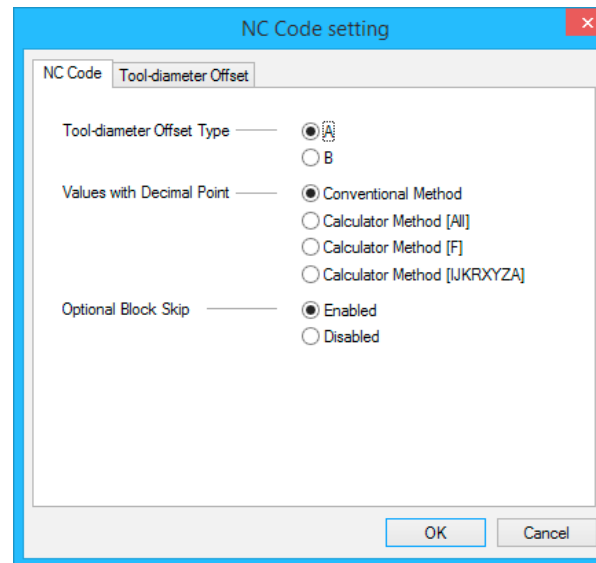

Display	Function
Tool-diameter Offset Type	This selects the type of correction (offset) for the tool diameter. The locus through which the tool passes differs according to the offset type. For more information, refer to the "NC Code Reference Manual." ☞ Separate volume "NC Code Reference Manual"
Values with Decimal Point	This selects the method of interpretation for the numerical values in NC codes. Conventional Method : Values are interpreted as millimeters (or inches) when they contain a decimal point, or as thousandths of a millimeter (or ten-thousandths of an inch) when no decimal point is present. Calculator Method : Values are always interpreted as millimeters (or inches) regardless of whether a decimal point is present. When calculator-method interpretation is used, you choose the range of application for the method.
Optional Block Skip	This setting determines whether optional blocks are skipped.

Tool-Diameter Offset Tab

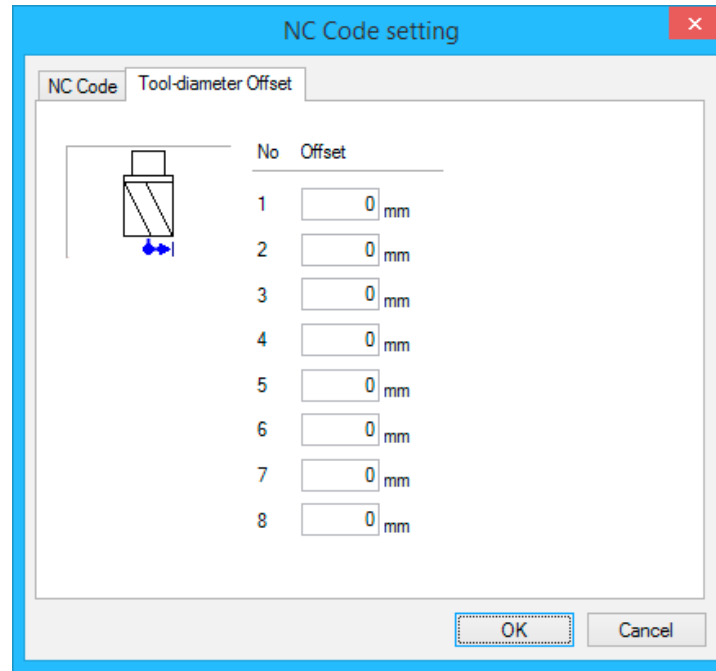

Display	Function
Offset	This sets the tool-diameter offset for NC codes. If the tool-diameter offset is not set by G10, these are used.

Test Cut Dialog in NC Code

For a cutting data file written in NC code, test output is possible on the VPanel to check it for the presence of mistakes (bugs).

☞ **“Cut Dialog”** (p. 17)

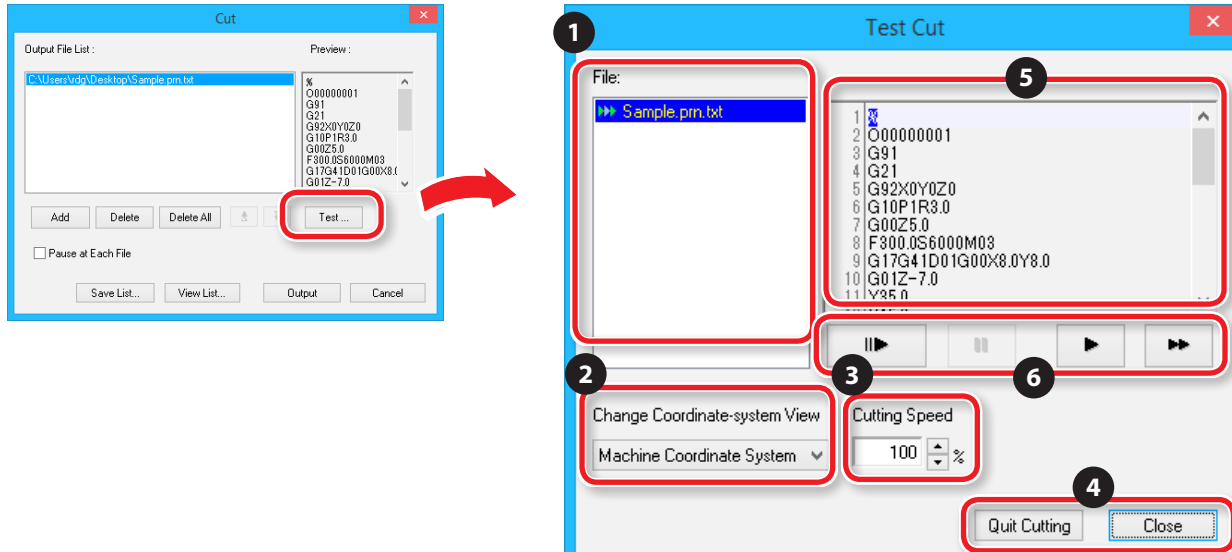

Test output conditions

- When the current command set is **“NC code.”**
- When the selected file is **“NC code.”**

No.	Display	Function	No.	Display	Function
①	File	The files whose output you want to test are displayed here.	⑤		The code of the file whose output you want to test is displayed here.
②	Change Coordinatesystem view	Select the coordinate system that is used to display the coordinates in the VPanel’s main window.	⑥		Click this button to generate test output one block at a time. When you click this button, the next block is executed.
③	Cutting Speed	You can adjust the feed rate of the cutting tool. ☞ “Adjusting the Feed Rate and Spindle Speed During Cutting” (p. 106) Setting unit : 10% Setting range : 10% to 200%			Click this button to pause the test output. When you click this button while test output is paused, output begins again.
④	Quit Cutting	Click this button during cutting to stop cutting.			Click this button to execute output as indicated by the program.
	Close	Close this dialog.			Click this button to execute test output at the maximum cutting tool feed rate. All operations other than the cutting tool feed rate are executed according to the program.

NC Code Specifications

List of Settings Related to NC Code

The following list contains the settings related to interpreting and executing NC code that can be performed on the machine. Use NC programs to perform all other settings.

☞ Separate volume **"NC Code Reference Manual"**

- If you want to make settings related to NC code, set the command set to **"NC Code"** or **"RML-1/NC Code."**

☞ **"Command Set"** (p. 15)

Numeric Value Interpretation Method

Select the interpretation method for numeric values with a decimal point and the calculator interpretation range. On the VPanel, click **[Setup]** and then **[NC Code setting]**. Then set these values on the **[NC Code]** tab.

☞ **"Command Set"** (p. 15)

Workpiece Origin Offset (G54 to G59)

This setting is related to the location of the origin of the workpiece coordinate system. Select the coordinate system that you want to set under **"Set Origin Point"** on the VPanel, and then set the origin. You can also use NC programs to set the G10 and G92 coordinate systems.

EXOFS

Follow the setting method described below.

- 1. Set the display of the coordinate system on the VPanel to **[Machine Coordinate System]**.**
- 2. Click the feed buttons on the VPanel to set the X, Y, and Z coordinates.**
- 3. Set the coordinate system under **"Set Origin Point"** to **[EXOFS]**.**
- 4. Set the X/Y origin and the Z origin.**

You can also use NC programs to set the G10 coordinate system.

Tool-Diameter Offset Value

On the VPanel, click **[Setup]** and then **[NC Code setting]**. Then set this value on the **[Tool-diameter Offset]** tab. You can also use NC programs to set the G10 coordinate system.

Tool-Diameter Offset Type (G41, G42)

Select type A or type B. On the VPanel, click **[Setup]** and then **[NC Code setting]**. Then set this value on the **[NC Code]** tab.

Optional Block Skip (/)

Enable or disable the optional block skip feature. On the VPanel, click **[Operation Settings]** and then **[NC Code setting]**. Then set this value on the **[NC Code]** tab.

Items Related to the Mechanical Specifications

This section describes the NC codes that are dependent on the machine's mechanical specifications.

☞ Separate volume **"NC Code Reference Manual"**

Dimension Word

Of the four dimension words - X, Y, Z, and A - only X, Y, and Z are supported.

Data Settings (G10)

The ranges of the G10 parameters are as follows.

Parameter : Number

Function : Compensation number

Acceptable range : 1 to 8

Valid range : 1 to 8

Parameter : Radius

Function : Tool-diameter offset value

Acceptable range : Range 1

Valid range : 0 to 10 mm (0 to 0.3937 inches)

Tool-Diameter Offset (G41, G42)

The ranges of the G41 and G42 parameters are as follows.

Parameter : Number

Function : Offset number

Acceptable range : 0 to 8

Valid range : 0 to 8

Feed Rate (F)

The range of the F parameter is as follows.

Parameter : Feed rate

Function : Feed rate

Acceptable range : Range 1

Valid range:

X and Y axes : 6 - 1800 mm/min (0.24 - 70.87 inch/min)

Z axis : 6 - 1800 mm/min (0.24 - 70.87 inch/min)

Interpretations of NC Code Omissions

When NC codes are omitted, the machine performs the following interpretations. The machine performs interpretations when NC codes are omitted in a characteristic manner. If you want to write general-purpose programs, do not omit NC codes.

☞ Separate volume **“NC Code Reference Manual”**

Unit Setting (G20, G21)

If these codes are omitted, the machine assumes millimeter input (G21) at all times.

Tool-Diameter Offset (G41, G42)

If these codes are omitted, the value that was set on the **[Tool-diameter Offset]** tab, which is accessed by clicking **[Setup]** and then **[NC Code setting]** on the VPanel, is used.

Workpiece Coordinate System (G54 to G59)

If these codes are omitted, the machine assumes workpiece coordinate system 1 (G54) at all times.

Dimension (G90, G91)

If these codes are omitted, the machine assumes absolute (G90) at all times.

Feed Rate (F)

If the F code is omitted, the feed rate is set to 120 mm/min (4.72 inches/min).

Word List

The words supported by this machine are listed in the following chart. For details on each word, see the "[NC Code Reference Manual](#)."

Preparation Feature (G feature)

Group Name	Word	Function	Continuation Function
Positioning and interpolation	G00	Positioning	Modal
	G01	Linear interpolation	
	G02	Clockwise circular interpolation	
	G03	Counterclockwise circular interpolation	
	G04	Dwell	One-shot
	G10	Data setting	One-shot
Plane selection	G17	Select X-Y plane	Modal
	G18	Select Z-X plane	
	G19	Select Y-Z plane	
Unit setting	G20	Inch input	Modal
	G21	Millimeter input	
	G28	Return to reference point	One-shot
	G39	Corner offset circular interpolation	One-shot
Tool-diameter offset	G40	Cancel tool-diameter offset	Modal
	G41	Tool-diameter offset -- left	
	G42	Tool-diameter offset -- right	
	G53	Movement under machine coordinate system	One-shot

Group Name	Word	Function	Continuation Function
Workpiece coordinate system	G54	Select workpiece coordinate system 1	Modal
	G55	Select workpiece coordinate system 2	
	G56	Select workpiece coordinate system 3	
	G57	Select workpiece coordinate system 4	
	G58	Select workpiece coordinate system 5	
	G59	Select workpiece coordinate system 6	
Fixed cycle	G80	Cancel fixed cycle	Modal
	G81	Fixed cycle	
	G82	Fixed cycle	
	G83	Fixed cycle	
	G85	Fixed cycle	
	G86	Fixed cycle	
	G89	Fixed cycle	
Dimension	G90	Absolute	Modal
	G91	Incremental	
	G92	Cancel fixed cycle	One-shot
Return point	G98	Initial level return	Modal
	G99	Point R level return	

Support Features (M feature), Feed Feature (F feature)

Word	Function	Function Start		Function Continuation	
		Same Time as the Operation Specified by the Command in the Block	After the Operation Specified by the Command in the Block Is Complete	Held until the Command Is Canceled or Changed	Only Valid in the Block Specified by the Command
M02	End of program	Yes			Yes
M03	Spindle revolution	Yes		Yes	
M05	Spindle stop	Yes		Yes	
M30	End of program	Yes			Yes
F	Feed rate	Yes		Yes	

Other Words

Word	Function
I	Dimension word
J	Dimension word
K	Dimension word
N	Sequence number
O	Program number
R	Dimension word
X	Dimension word
Y	Dimension word
Z	Dimension word
/	Optional block skip
%	Data start/data end
<EOB>	End of block
()	Comment

Maintenance

Important Notes on Care and Maintenance 118

Cleaning after Cutting Operation Ends 119

Cleaning the X-/Z-Shafts 119

Replacement of the Consumable Parts 122

Caution and Note for Replacement of the Consumable Parts 122

Replacement Cycles and Replacement Methods of Consumable Parts 122

Confirm the Total Spindle Motor Rotation Time 123

Run in the Spindle 124

Replacement the Table 125

What to Do If... 126

Initialization Is Not Performed / Initialization Fails 126

VPanel Does Not Recognize the Machine 126

Operations Are Ignored 127

The Spindle Doesn't Rotate / Spindle Rotation Speed Is Wrong 128

The Feed Rate is Wrong 128

Abnormal Cutting is Performed 129

The Origin is Misaligned 129

The Cutting Results are Not Attractive 130

It Takes Time to Delete Data After Quitting Cutting 130

The Cutting Tool Rises at an Unintended Point in the Course of Cutting 130

The Power Turns Off After Cutting Ends 131

The Cutting Tool Does Not Reach the Material 131

The Driver Cannot Be Installed 131

Uninstalling the Driver 133

Abnormal Noise Occurs 135

Changing the Position of a Spindle Unit 138

Initializing This Machine's Settings 141

Displaying This Machine's Settings 142

Confirm the Version Information 143

Sample files are not found 143

Responding to Error Messages 144

Message is Displayed 144

Important Notes on Care and Maintenance

WARNING

Never use a pneumatic blower.

This machine is not compatible with a pneumatic blower. Cutting waste may get inside the machine and cause fire or electrical shock.

WARNING

Never use gasoline, alcohol, thinner, or any other flammable material for cleaning.

Doing so may cause fire.

WARNING

Always unplug the power cord when attaching or removing parts and optional parts.

Attempting such operations while the machine is connected to a power source may result in injury or electrical shock.

WARNING

When using a dust collector to collect cutting waste, exercise caution to prevent fire and explosions of dust.

Using an ordinary dust collector to collect fine cuttings may lead to fire or explosions. Contact the dust collector manufacturer to check whether the dust collector can be used to collect cutting waste. If you cannot confirm that it is safe to use the dust collector, use a brush or similar tool to collect cutting waste. Do not use the dust collector.

CAUTION

Caution: high temperatures.

The cutting tool and spindle motor become hot. Exercise caution to avoid fire or burns.

CAUTION

Do not touch the tip of the blade with your fingers.

Doing so may result in injury.

CAUTION

Be sure to follow the procedure provided in this manual. You must not touch any parts except for those specified in the instructions.

An unexpected operation of the machine may cause injury and burn.

- This machine is a precision device. Carry out daily care and maintenance.
- Carefully clean away cutting waste. Operating the machine with a large amount of cutting waste present may cause malfunction.
- Never apply silicone substances (oil, grease, spray, etc.) to the machine. Doing so may cause poor switch contact.

Cleaning after Cutting Operation Ends

Cleaning the X-/Z-Shafts

After processing is completed, please be sure to remove cutting waste. It becomes a cause of malfunction.

Items to Prepare Yourself

- Commercially brush

Procedure

1. Remove the material that has finished being cut and the cutting tool.

When the material cannot be removed well, it removes using wooden spatulas etc.

2. Click [View] of VPanel.



3. Push [⏻] (Power) button.

Turn off the machine's power.

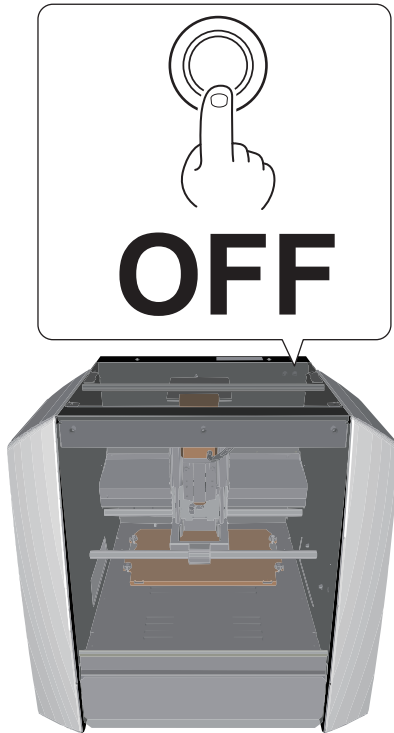

⚠️ WARNING

Perform this task with all power switches left switched off.
Otherwise sudden movement of the machine may cause injury.

4. Brush off the cutting waste that has fallen on the X- and Z- shafts and around the table using a commercially available brush.

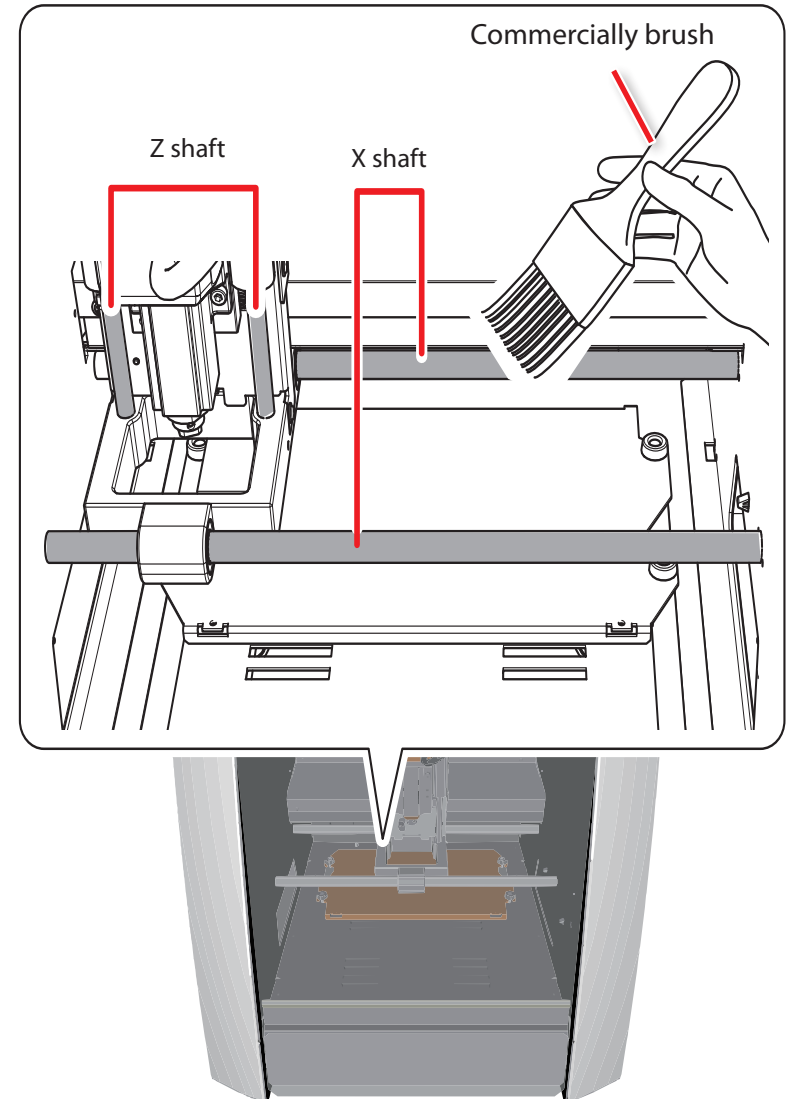

- 5.** Brush the cutting waste down into the dust tray from the positions indicated on the figure below.

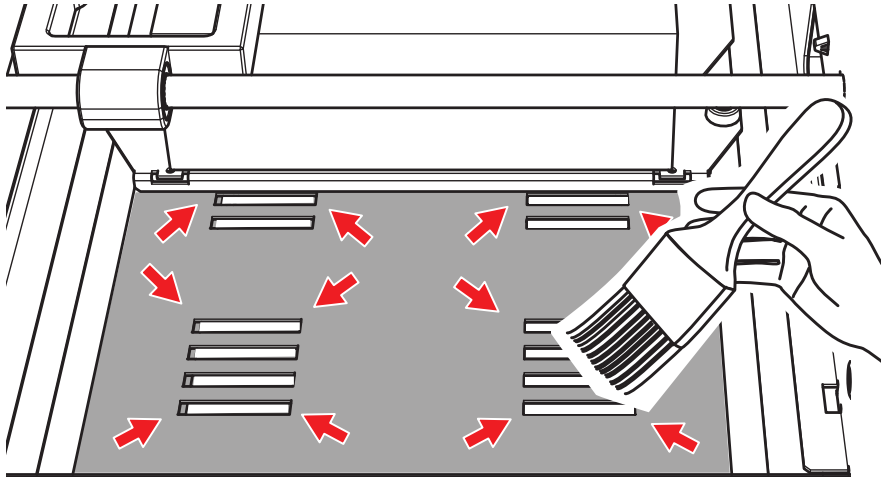

- 6.** Remove the cutting waste that has collected in the dust tray.

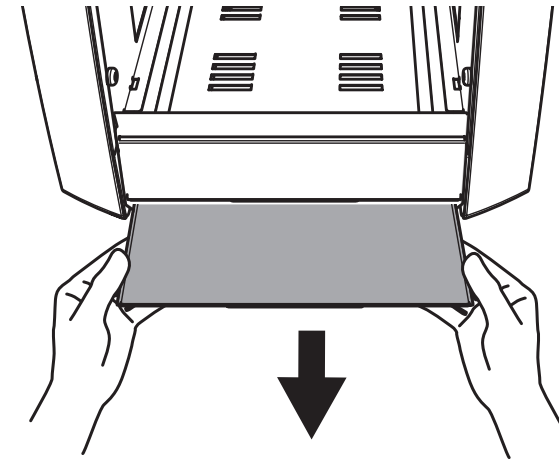

Replacement of the Consumable Parts

Caution and Note for Replacement of the Consumable Parts

- There are various consumable parts in this machine. To request consumable parts, visit the DGSHAPE Corporation website. (<http://www.dgshape.com/>)
- If you have any questions, refer to the DGSHAPE Corporation website (<http://www.dgshape.com/>). If you cannot access the website, contact your authorized Roland DG Corporation dealer.
- Use the specified consumable parts.

Replacement Cycles and Replacement Methods of Consumable Parts

Please check the following table for the types of consumable parts and the replacement cycle guidelines and replacement methods for them.

Consumable parts	Standard replacement periods	Replacement method
Spindle Motor	500 hours ☞ “Confirm the Total Spindle Motor Rotation Time” (p. 123)	Refer the manual included with the consumable part ☞ “Run in the Spindle” (p. 124)
Spindle Unit	1000 hours	Refer the manual included with the consumable part ☞ “Run in the Spindle” (p. 124)
Collet	When required at the time of cutting tool replacement	☞ “STEP 4 : Attach the Cutting Tool” (p. 84)
Table	When the table is broken	☞ “Replacement the Table” (p. 125)

Confirm the Total Spindle Motor Rotation Time

The total time of rotation of spindle motor can be checked by VPanel. You can reference for getting to know replacement time.

Usage example

Avoiding stoppages during cutting

You can check whether the spindle motor that is currently in use has a long enough work life remaining to complete the cutting operation that you have planned. This enables you to avoid situations in which the spindle motor stops working during cutting.

Economic usage

You can check whether there are any spindle motors available that have enough of a work life remaining to efficiently complete the cutting operation that you have planned. This enables you to use spindle motors economically.

CAUTION

When replacing the spindle motor, if you forget to change the motor number or forget to perform a reset, the current working time will be added to the working time of the motor before being replaced, and you will be unable to manage the working time.

Procedure

1. On the VPanel, click  at the upper left of a screen, and click **[Maintenance]**.

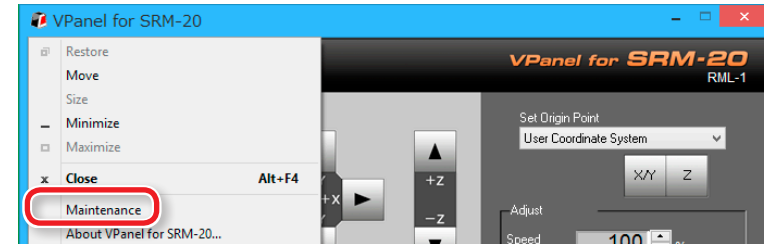

2. Check the total spindle motor rotation time.

The total time of rotation of the spindle motor is displayed.

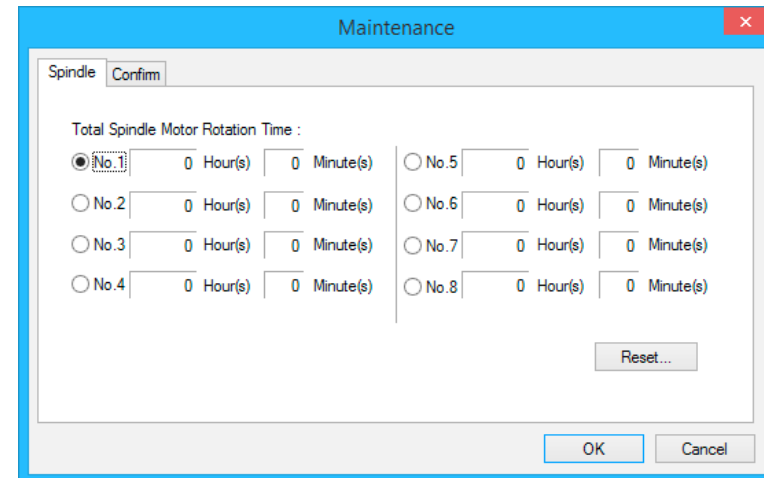

Reset the Total Rotation Time of Spindle Motor

Reset the total working time for the selected number. Click **[Reset]** and a confirmation message is displayed. Click **[OK]** to finish the reset. You cannot undo a reset operation.

Run in the Spindle

After replacing the spindle unit and spindle motor, run in the spindle.
Failure to run in the spindle may result in unstable spindle rotation.

Procedure

1. Move the slider to **[Low]** on the VPanel.

2. Click **ON**.

- Guide : Approx. 5 minutes

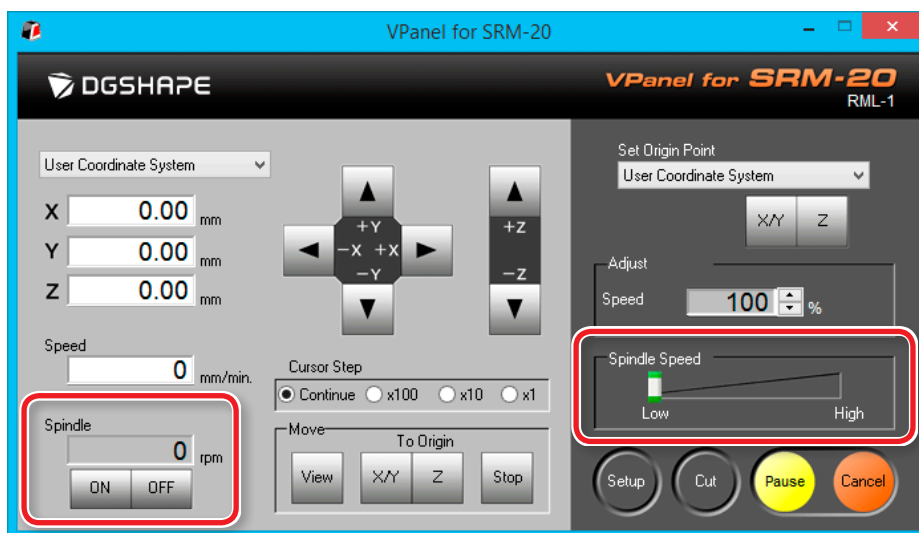

3. Move the slider to the center.

- Guide : Approx. 5 minutes

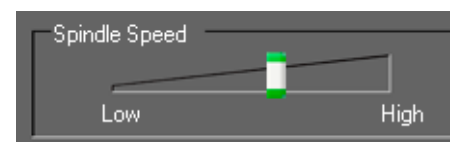

4. Move the slider to **"High."**

- Guide : Approx. 10 minutes



5. Click **OFF**, when the guide time passes.

MEMO

We recommend resetting the total working time or changing the management number in VPanel after replacing the spindle motor.

☞ **"Reset the Total Rotation Time of Spindle Motor"** (p. 123)

Replacement the Table

Procedure

1. Remove a material and cutting tool mounted on the machine.
2. Click [**View**] of VPanel.
3. Pull down the front guard and loosen the screws at the positions shown in the figure.

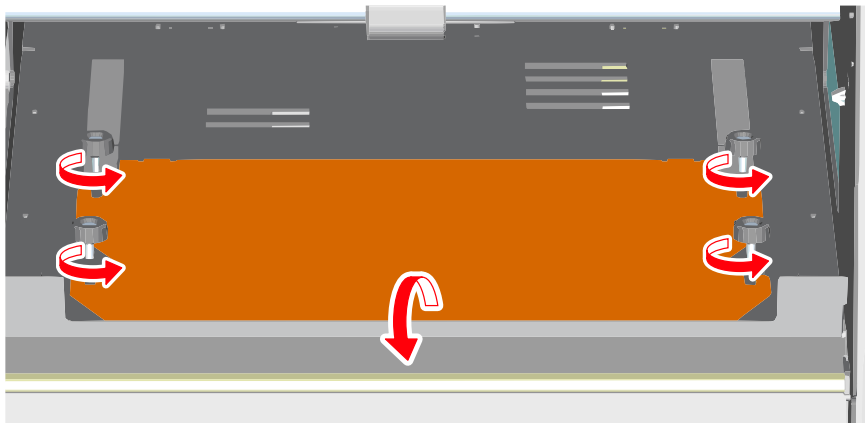

4. Remove the table.

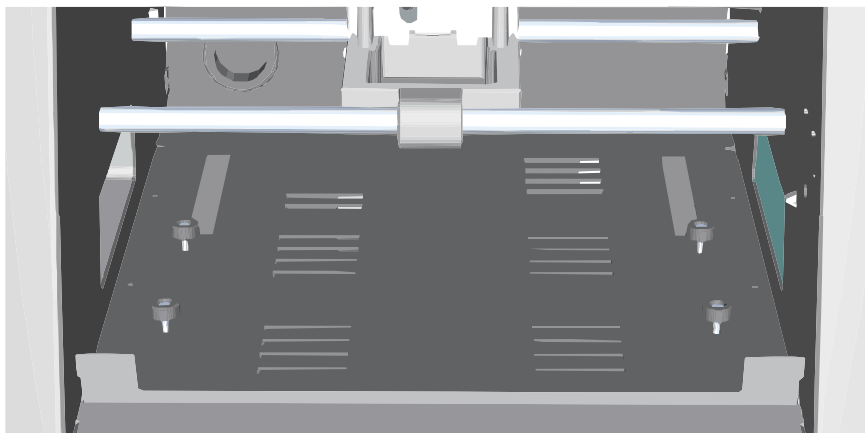

5. Fit the new table into the screw notches.

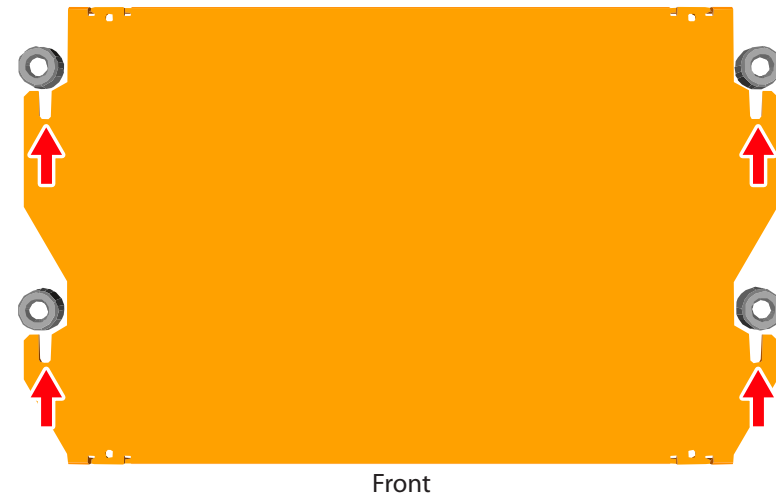

6. Tighten the screws firmly and return the front guard to the original position.

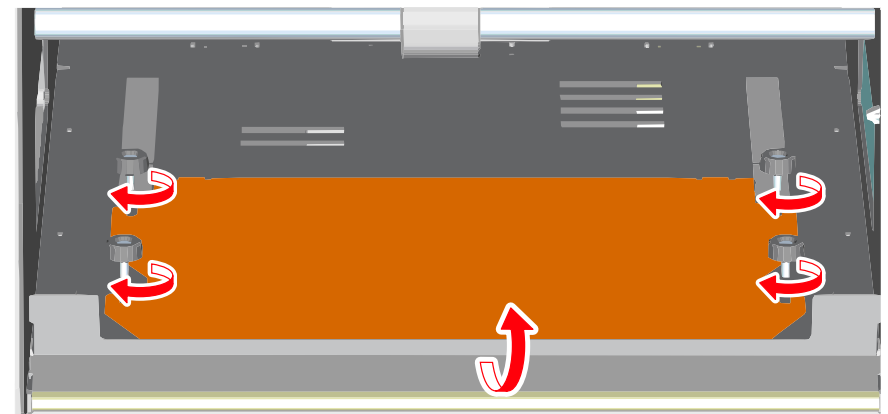

What to Do If...

Initialization Is Not Performed / Initialization Fails

Is a Front Cover Open?

When starting the machine, make sure that the front cover is closed. For safety, initialization is not performed when a cover remains open at startup.

Is a Front Guard Pull Down ?

When the front guard falls down, the front cover can not be closed firmly. Therefore the machine is not performed.

☞ **"Part Names and Functions"** (p. 9)

Is a Large Amount of Cutting Waste Present?

Clean away any cutting waste. Clean the area around the spindle head especially carefully.

☞ **"Cleaning the X-/Z-Shafts"** (p. 119)

Is a Large Amount of Cutting Waste Present in the Dust Tray?

Clean away any cutting waste in the dust tray.

☞ **"Cleaning the X-/Z-Shafts"** (p. 119)

Is Anything Caught on the Spindle Head or Rotary Axis Unit?

Check whether something has become caught and is impeding initialization.

VPanel Does Not Recognize the Machine

Has Initialization Been Completed?

Has initialization been completed? Before you start VPanel, first switch on the power to the machine.

☞ **"Start VPanel"** (p. 11)

Is the Computer Connected?

Check whether the connector cable has come loose. Please use the included cable.

Is the Driver Installed Correctly?

If the connection to the computer is not made in the sequence described, the driver may fail to be installed correctly. VPanel does not function normally when driver is misconfigured. Check again to ensure that the connection was made using the correct procedure.

☞ Download **"<http://startup.rolanddg.com>"**

☞ **"The Driver Cannot Be Installed"** (p. 131)

Operations Are Ignored

Is the Cable Connected?

Check whether the connector cable has come loose. Please use the included cable.

Was the Machine Started According to the Correct Procedure?

Before you start VPanel, switch on the power to the machine.

☞ **"Start VPanel"** (p. 11)

Is a Front Cover Open?

This machine restricts some operations when a front cover is open. Close the front cover.

Is a Front Guard Pull Down ?

When the front guard falls down, the front cover can not be closed firmly. Therefore the machine is not performed.

☞ **"Part Names and Functions"** (p. 9)

Is Anything Caught on the Spindle Head or Rotary Axis Unit?

Check whether something has become caught and is impeding initialization.

Is a Large Amount of Cutting Waste Present?

Clean away any cutting waste. Clean the area around the spindle head especially carefully.

☞ **"Cleaning after Cutting Operation Ends"** (p. 119)

Is Operation Paused?

When the machine is paused, cutting stops and some operations are restricted. When you press the **"RESUME"** button of VPanel, the pause is canceled.

☞ **"Pausing / Resuming"** (p. 104)

Is the Driver Installed Correctly?

If the connection to the computer is not made in the sequence described, the driver may fail to be installed correctly. VPanel does not function normally when driver is misconfigured. Check again to ensure that the connection was made using the correct procedure.

☞ Download **"<http://startup.rolanddg.com>"**

☞ **"The Driver Cannot Be Installed"** (p. 131)

Is VPanel Displaying an Error Message?

☞ **"Responding to Error Messages"** (p. 144)

The Spindle Doesn't Rotate / Spindle Rotation Speed Is Wrong

Is a Front Cover Open?

When starting the machine, close the front cover. For safety, initialization is not performed when a cover remains open at startup.

Is a Front Guard Pull Down ?

When the front guard falls down, the front cover can not be closed firmly. Therefore the machine is not performed.

☞ **"Part Names and Functions"** (p. 9)

Is a Large Amount of Cutting Waste Present?

Clean away any cutting waste. Clean the area around the spindle head especially carefully.

☞ **"Cleaning after Cutting Operation Ends"** (p. 119)

Is It the Replacement Time of a Spindle Motor?

Spindle motor is consumable. If it is used for 500 hours or more, replace for a new spindle motor.

☞ **"Replacement of the Consumable Parts"** (p. 122)

Is It the Replacement Time of a Spindle Unit?

Spindle unit is consumable. If it is used for 1000 hours or more, replace for a new spindle unit.

☞ **"Replacement of the Consumable Parts"** (p. 122)

Even if it replaces spindle motor/unit, when not being repaired

Contact your authorized Roland DG Corporation dealer where you purchase the machine.

Has the Spindle Speed been Adjusted (Override)?

An adjusting rotation of spindle changes the rotation speed.

Unless you have a special reason for changing them, leave all overrides set at **"High."**

The Feed Rate is Wrong

Has the Feed Rate been Adjusted (Override) ?

An override changes the feed rate. Check the settings for adjustment value. Unless you have a special reason for changing them, leave override set at 100%.

☞ **"Adjusting the Feed Rate and Spindle Speed During Cutting"** (p. 106)

Abnormal Cutting is Performed

Is a Large Amount of Cutting Waste Present?

Clean away any cutting waste. Clean the area around the spindle head especially carefully.

☞ **“Cleaning the X-/Z-Shafts”** (p. 119)

Is the Location of the Origin Set Correctly?

Check whether the origin has been set correctly. An incorrect origin location may result in cutting at an unintended position.

☞ SRP Player : **“Origin point of the Model / Origin point”** (p. 96)

☞ MODELA Player 4 : **“Origin point of the Model / Origin point”** (p. 54)

☞ **“STEP 2 : Set the Origin Point”** (p. 89)

Is the Command Set Correct?

Make sure the appropriate command set for the program you're using has been selected. An incorrect command mode may lead to errors, unintended operation, or no operation.

☞ **“Setup Dialog”** (p. 15)

☞ **“STEP 3 : Confirm the Command Set”** (p. 83)

The Origin is Misaligned

Is the Correct Workpiece Coordinate System Selected?

In the NC program, there are six coordinate systems. Depending on which coordinate system is used, the position of the origin differs. For instance, if the NC program uses G55, the origins must be set relative to workpiece coordinate system G55.

☞ SRP Player : **“Origin point of the Model / Origin point”** (p. 96)

☞ MODELA Player 4 : **“Origin point of the Model / Origin point”** (p. 54)

☞ **“STEP 2 : Set the Origin Point”** (p. 89)

☞ Separate volume **“NC Code Reference Manual”**

Has the EXOFS Setting been Made?

The EXOFS in the NC code have a function to shift the origin. Set EXOFS to zero, then redo the settings for the origins. If the origin is still shifted, check the program.

How to set EXOFS to zero

1. Select **[Machine Coordinate System]** from the display of the coordinate system on the VPanel.
2. Move the tool position to **“X: 0”, “Y: 0”, “Z: 0”**
3. Select **[EXOFS]** at the **[Set Origin Point]**.
4. Click **[X/Y]** and **[Z]** at the **[Set Origin Point]**.

The Cutting Results are Not Attractive

Is the Table Certainly Fixed?

The screw of the table may not be fixed firmly.

☞ **“Replacement the Table”** (p. 125)

Is the Material Certainly Fixed?

There will be bad influence on the cutting result if the material is not firmly attached to the table or scrap board. Increase the number of double-stick tape and fix firmly.

☞ **“STEP 1 : Attach the Material to the Table”** (p. 88)

Is the Cutting Tool Certainly Fixed?

Retighten the set screw of a collet and fix firmly.

☞ **“STEP 4 : Attach the Cutting Tool”** (p. 84)

Is the Cutting Tool Tip Worn?

If the tip of the cutting tool is worn, replace with a new cutting tool.

☞ **“STEP 4 : Attach the Cutting Tool”** (p. 84)

Is the Cutting Condition Optimal?

The optimal cutting parameters are determined by a balance of such factors as the hardness of the material, the feed rate, the spindle rotating speed, the cutting-in depth, and the capacity of the cutting tool. Refer to the results and try fine tuning the parameters.

It Takes Time to Delete Data After Quitting Cutting

Depending on the state of the computer in use, deletion of processing data may take time. Please delete by the following method.

Procedure

1. Click [**Device and Printer**] (or [**Printer and FAX**]) from start menu.
2. Double-click [**Roland SRM-20**].
3. [**Roland SRM-20**] dialog is displayed.
4. In the [**Roland SRM-20**] dialog, select the cutting data which you want to delete, click [**Document**] - [**Cancel**].
5. If cutting data disappears from [**Roland SRM-20**] dialog, it will be the completion of deletion.

The Cutting Tool Rises at an Unintended Point in the Course of Cutting

Is the Entire Tool Path within the Cuttable Range?

Any portions of the tool path outside the cuttable range are ineligible for cutting. Therefore, the cutting tool rises when it reaches the end of the cuttable range. When the tool path falls within the cuttable range, the cutting tool returns to normal cutting operation.

Review and correct the maximum cutting range of the machine and the origin point so that the entire tool path falls within the cuttable range.

☞ **“Cutting Area”** (p. 21)

The Power Turns Off After Cutting Ends

Is the Auto-Power-Off Function Set Up?

If auto power-off function is enabled on the power option, the power automatically turns off when a certain period of time elapses with the machine idle*.

* **“Idle”** means the state in which the movement of the table and spindle head is stopped (except when a machining process is paused).

You can disable the auto power-off function or change the set time.

☞ **“Power Option”** (p. 15)

The Cutting Tool Does Not Reach the Material

Are You Using a Scrap Board?

If the cutting tool does not reach the material and cannot cut it, use a scrap board.

☞ **“Cutting Material / Scrap Boards”** (p. 20)

The Driver Cannot Be Installed

If installation quits partway through, or if the wizard does not appear when you make the connection with a USB cable, take action as follows.

Windows 8/8.1

1. Use a USB cable to connect the machine and the computer, and then turn the machine on.
2. If the **“Found New Hardware”** wizard appears, click **[Cancel]** to close it. Disconnect any USB cables for printers other than this machine.
3. On the task bar, click **[Start]**, and then **[Desk top]**. Move the mouse to the lower right corner to display Charm and click **[Set]**.
4. Click **[Control Panel]**, **[Hardware and Sound]**, and then **[Device Manager]**. When the **“User Account Control”** dialog box appears, click **[Continue]**. The **“Device Manager”** window appears.
5. Click **[Show hidden devices]** on the **[View]** menu.
6. Double-click **[Printers]** or **[Other devices]** in the list. Click the model name or **[Unknown device]**, whichever appears below the item you selected.
7. Click **[Delete]** on the **[Action]** menu.

8. In the “**Confirm Device Uninstall**” dialog box, select the **[Delete the driver software for this device]** check box, and then click **[OK]** to close the “**Device Manager**.”
9. Disconnect the USB cable that is connected to the printer, and then restart Windows.
10. Uninstalling the driver for the relevant device.
11. Follow the procedure “**Uninstalling the Driver**” (p. 133) to uninstall the driver.
12. Follow the procedure “**Installing the Driver**” to install the driver again.
 - ☞ “<http://startup.rolanddg.com>”
5. Click **[Show hidden devices]** on the **[View]** menu.
6. Double-click **[Printers]** or **[Other devices]** in the list. Click the model name or **[Unknown device]**, whichever appears below the item you selected.
7. Click **[Delete]** on the **[Action]** menu.
8. In the “**Confirm Device Uninstall**” dialog box, select the **[Delete the driver software for this device.]** check box, and then click **[OK]** to close the “**Device Manager**.”
9. Disconnect the USB cable that is connected to the printer, and then restart Windows.

Windows 7

1. Use a USB cable to connect the machine and the computer, and then turn the machine on.
2. If the “**Found New Hardware**” wizard appears, click **[Cancel]** to close it. Disconnect any USB cables for printers other than this machine.
3. On the taskbar, click **[Start]**, and then right-click **[Computer]**. Click **[Properties]**.
4. Click **[Device Manager]**. When the “**User Account Control**” dialog box appears, click **[Continue]**.
The “**Device Manager**” window appears.
10. Uninstalling the driver for the relevant device.
Follow the procedure “**Uninstalling the Driver**” (p. 133) to uninstall the driver.
11. Follow the procedure “**Installing the Driver**” to install the driver again.
 - ☞ “<http://startup.rolanddg.com>”

Uninstalling the Driver

Follow the appropriate procedure below to uninstall the driver.

Windows 8/8.1

1. Turn the machine off, and disconnect the cable that is connecting the computer and the machine.
2. Log on to Windows as **“Administrator.”**
3. Click **[Desk top]**.
4. Move the mouse to the lower right corner to display Charm and click **[Set]**.
5. On the task bar, click **[Control Panel]**, and then **[Uninstall a program]**.
6. Select the machine’s driver that you want to uninstall, and then click **[Uninstall]**.
7. When a message prompting you to confirm that you want to uninstall the driver appears, click **[Yes]**.
8. On the task bar, click **[Start]**, and then **[Desk top]**.
9. Start Windows Explorer to open the drive and folder where the driver is located. (*Note)
10. Double-click the **“SETUP64.EXE”** (64-bit version) or **“SETUP.EXE”** (32-bit version).

11. When the **“User Account Control”** dialog box appears, click **[Continue]**.
The driver’s installer starts.
12. Click **[Uninstall]**.
Select the machine that you want to uninstall, and then click **[Start]**.
13. When a dialog box prompting you to restart the computer appears, click **[Yes]**.
14. After the computer is restarted, display the Control Panel and click **[View devices and printers]**.
15. If the icon of the device you wish to remove is shown, right-click on the icon to click on **[Remove device]**.
* If you do not have the driver, return to the Web Manual and download the driver.
☞ **“<http://startup.rolanddg.com>”**

Windows 7

1. Turn the machine off, and disconnect the USB cable that is connecting the computer and the machine.
2. Log on to Windows as **“Administrator.”**
3. On the task bar, click **[Start]**, **[Control Panel]**, and then **[Uninstall a program]**.

4. Select the machine's driver that you want to uninstall, and then click **[Uninstall]**.
5. When a message prompting you to confirm that you want to uninstall the driver appears, click **[Yes]**.
6. Start Windows Explorer to open the drive and folder where the driver is located. (*Note)
7. Double-click the **"SETUP64.EXE"** (64-bit version) or **"SETUP.EXE"** (32-bit version).
8. When the **"User Account Control"** dialog box appears, click **[Allow]**.
The driver's installer starts.
9. Click **[Uninstall]**.
Select the machine that you want to uninstall, and then click **[Start]**.
10. When a dialog box prompting you to restart the computer appears, click **[Yes]**.
When the computer restarts, the uninstallation is finished.

* If you do not have the driver, return to the Web Manual and download the driver.

☞ **"<http://startup.rolanddg.com>"**

Abnormal Noise Occurs

Is It the Replacement Time of a Spindle Unit?

Spindle unit is consumable. If it is used for 1000 hours or more, replace for a new spindle unit.

☞ **“Replacement of the Consumable Parts”** (p. 122)

Is It the Replacement Time of a Spindle Motor?

Spindle motor is consumable. If it is used for 500 hours or more, replace for a new spindle motor.

☞ **“Replacement of the Consumable Parts”** (p. 122)

Has the Grease Run Out?

If you hear an unusual noise when the spindle head is moving, apply grease to the shafts.

Items to Prepare Yourself

- Grease (Machine oil)
- Grease application stick (Swab etc.)

1. Apply the Grease

1. If a material, or cutting tool is mounted on the machine, remove it.
2. Move the spindle head.
 - 2-1. Click [**View**] of VPanel.
 - 2-2. Click [**-Z**] cursor key and it moves to the lowest position.

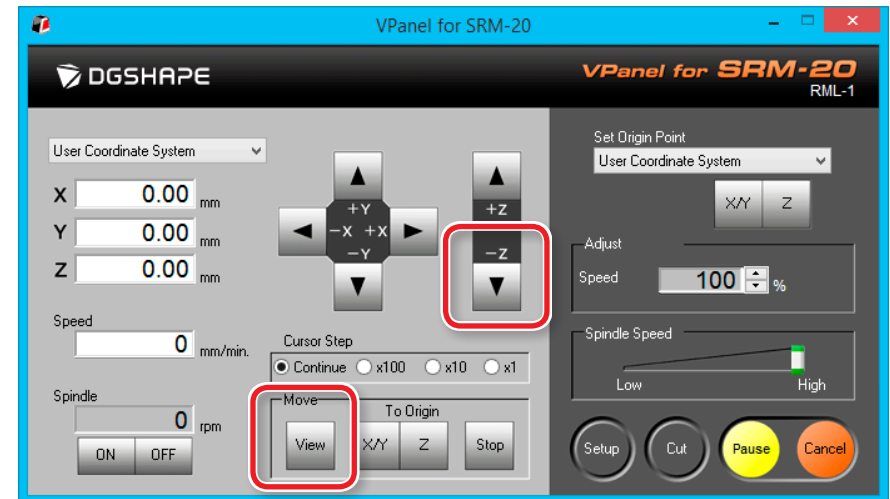

3. Push [⏻] (Power) button.

Turn off the power of the machine.

⚠️ WARNING Perform this task with all power switches left switched off. Otherwise sudden movement of the machine may cause injury.

4. Apply the grease to the shaft of X, Z.

Refer to the figure below, apply the grease to the shaft of each axis.

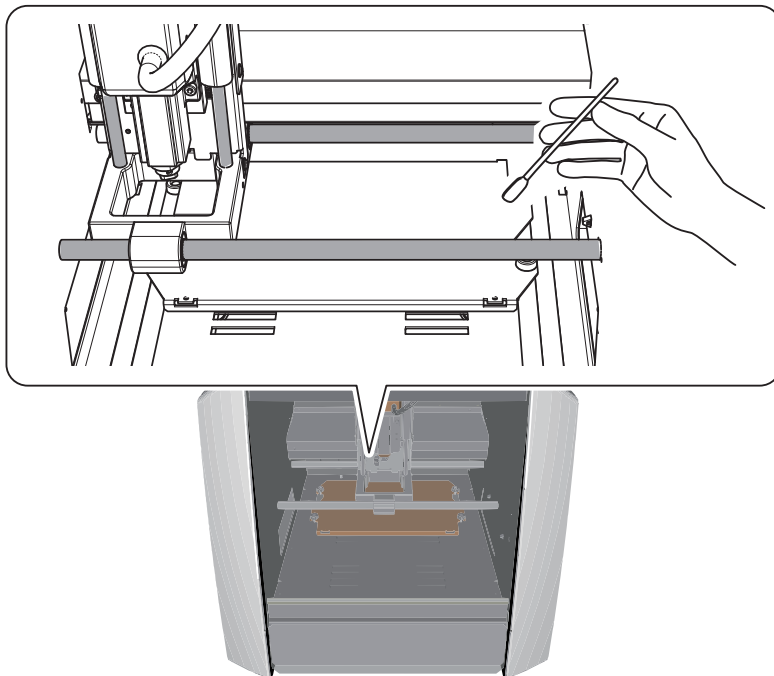

NOTE: When you apply the grease

If grease is applied superfluously, cutting waste will adhere and it will become a cause of malfunction.

2. Run in the machine.

1. Run in the machine.

☞ **“STEP 2 : The Machine Run-in”** (p. 81)

2. Excessive grease is wiped off.

If initial operation is completed, wipe off the excessive grease which accumulated on the shaft.

3. Check the state of motor load .

1. Click  at the upper left of a screen, and click [Maintenance].

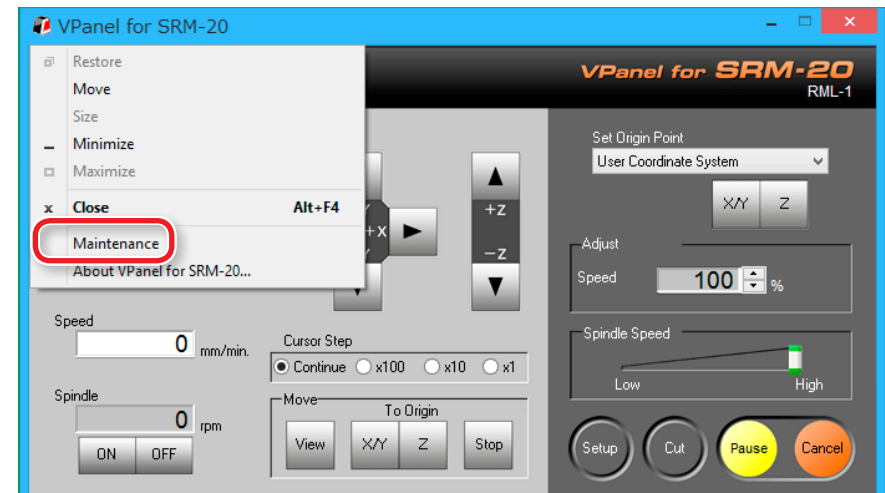

2. Click [Confirm] tab.

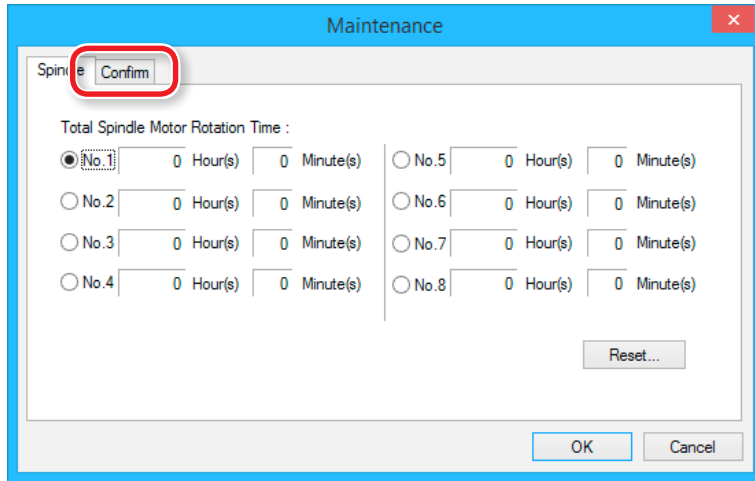

3. Select X, Y, or Z and click [Start].

Check the selected axis motor load. Perform checks on X, Y, and Z.

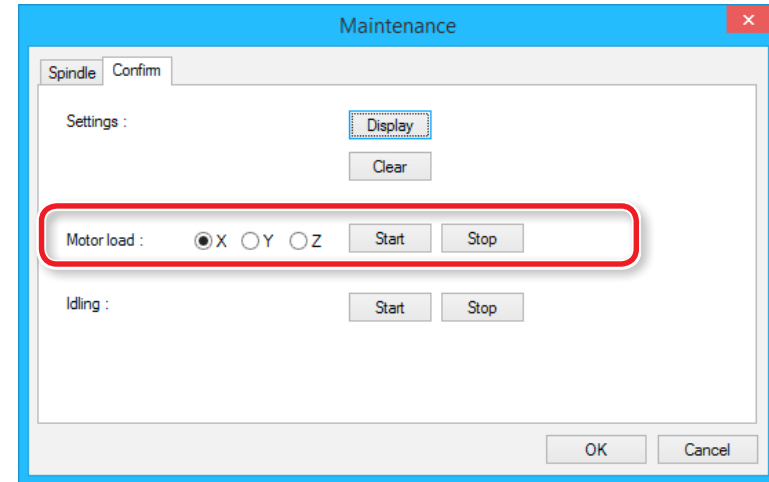

MEMO

Click **[Stop]** to end on the way.

If an unusual noise occurs or if it stops midway, apply grease again.

If the condition does not improve, contact your authorized Roland DG Corporation dealer where you purchase the machine.

Changing the Position of a Spindle Unit

☞ “Z Cutting Range by Changing the Position of the Spindle Unit” (p. 23)

Remove the Spindle Unit

⚠ CAUTION Never touch the spindle unit immediately after machining. Doing so may cause burns.

Procedure

1. If there is cutting waste inside the front cover, remove it.
2. If a material, collet, or cutting tool is mounted on the machine, remove it.
3. Move the spindle.
 - 3-1. Click [View] of VPanel.
 - 3-2. Move the Z axis to the lowest position.



4. Switch off the power and unplug the AC adapter from the power outlet.

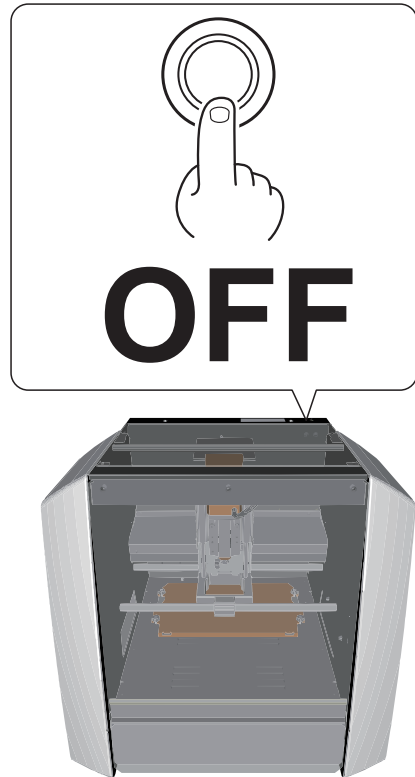

⚠️ WARNING

Always unplug the power cord when attaching or removing parts and optional parts. Attempting such operations while the machine is connected to a power source may result in injury or electrical shock.

⚠️ CAUTION

Under no circumstances move the spindle unit or table with your hands. Doing so may cause a breakdown.

5. Remove the spindle unit.

5-1. Remove the screws in the locations shown in the figure using a hexagonal wrench. (2 places)

5-2. Pull the spindle unit straight out and remove it.

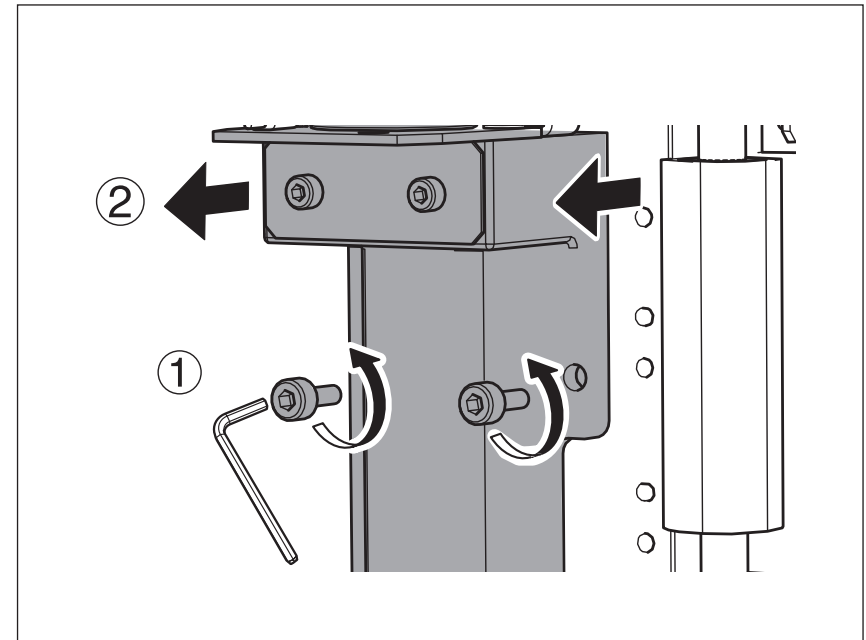

Attach the Spindle Unit

Perform the procedure 5 of **“Remove the Spindle Unit”** (p. 138) in reverse order.

☞ **“The attachment position of a spindle”** (p. 140)

CAUTION

If cutting waste builds up in the spindle unit or on the installation surface, the unit may be secured in place on an angle, resulting in problems. Thoroughly remove cutting waste.

The attachment position of a spindle

“Z Cutting Range by Changing the Position of the Spindle Unit” (p. 23)

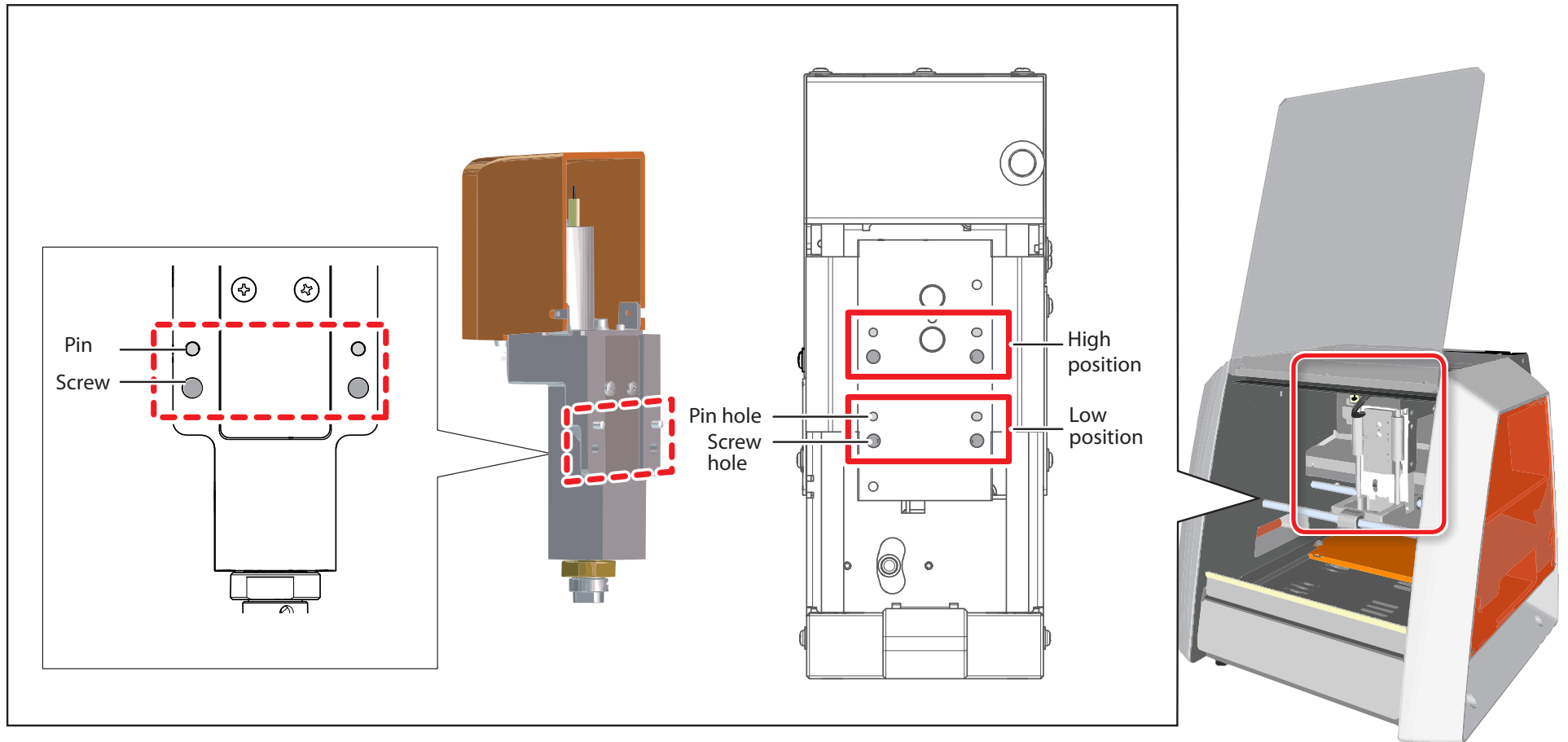

Initializing This Machine's Settings

Procedure

1. On the VPanel, click  at the upper left of a screen, and click [Maintenance].

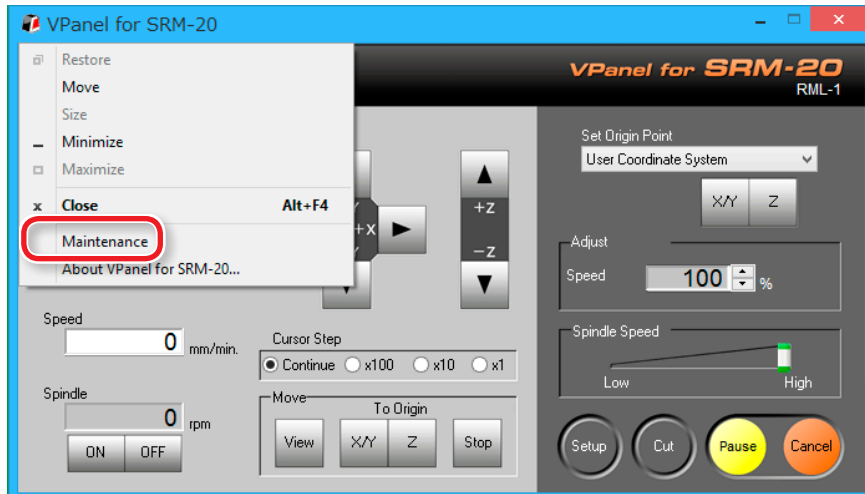

2. Click [Confirm] tab.

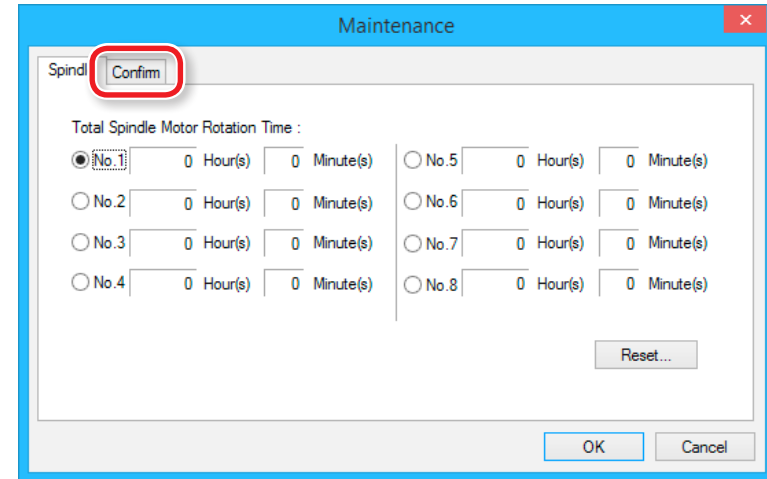

3. Click [Clear] of Settings.

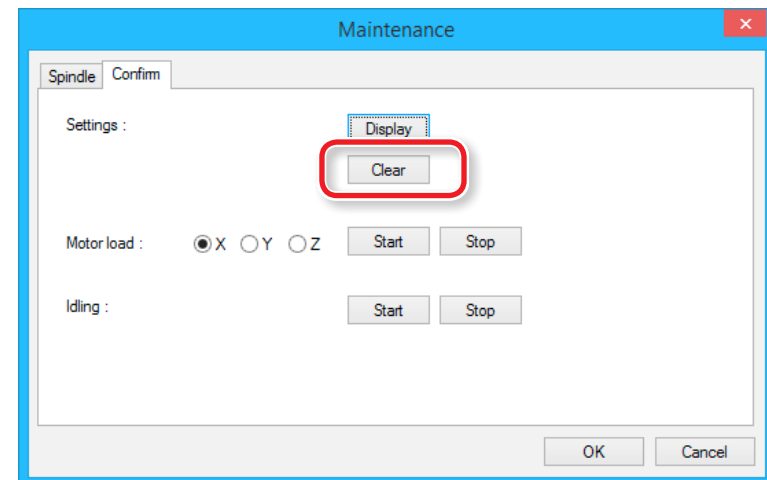

Displaying This Machine's Settings

You can use the VPanel to display the settings of this cutting machine as text, and also to save the settings as a text file. This feature is useful when you want to share settings between users, when you need to provide setup information when you request repairs for a malfunctioning machine, or under similar circumstances.

Procedure

1. On the VPanel, click  at the upper left of a screen, and click [Maintenance].

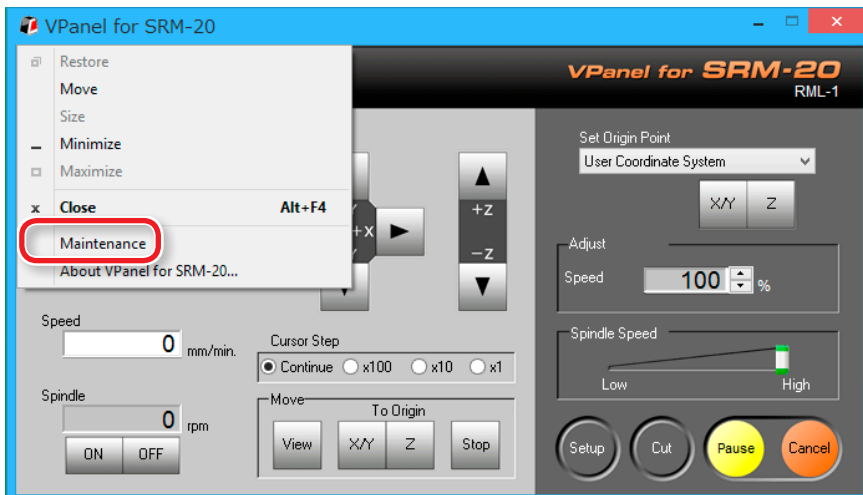

2. Click [Confirm] tab.

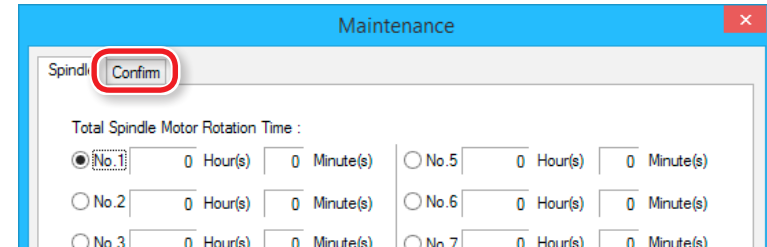

3. Click [Display] of Settings.

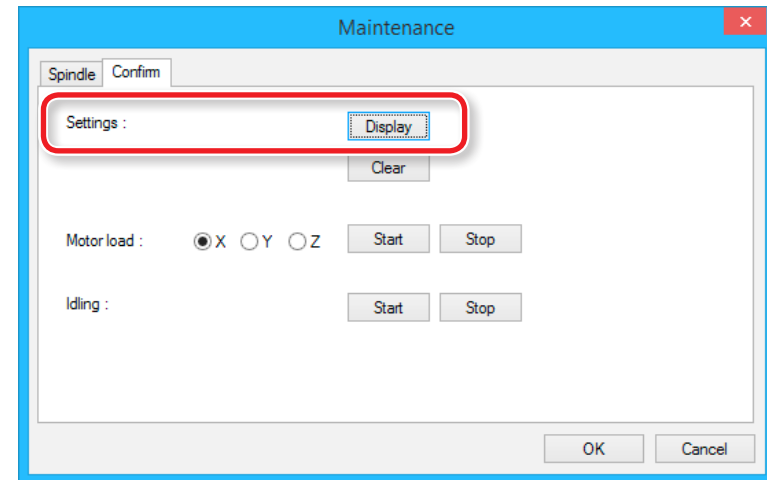

Confirm the Version Information

VPanel

Procedure

1. On the VPanel, click  at the upper left of a screen, and click **[Maintenance]**.
2. Click **[About VPanel]**.

SRP Player

Procedure

1. On the menu bar, click **[Help]**.
2. Click **[About SRP Player]**.

MODELA Player 4

Procedure

1. Click **[HELP]** in the menu bar.
2. Click **[About MODELA Player 4]**.

Sample files are not found

The folder that contains sample cutting data may not be visible depending on the settings of your computer. To display the folder that contains sample cutting data, use the following steps:

Procedure

1. Open any folder.
2. Do one of the following from the menu bar:
Windows 7 : Click **[Tool]** → **[Folder Options]**.
Windows 8/8.1 : Click **[View]** → **[Options]**.
3. Click the **[Display]** tab. In **[Display of files and folders]** under **[Advanced Settings]**, select **[Show hidden files, hidden folders, and hidden drives]**.
4. Click **[OK]**.

Responding to Error Messages

Message is Displayed

Message	Responding	Page
<p>No modeling machine was found.</p> <p>If the power is off, then switch it on.</p> <p>If the cable is unconnected, then connect it.</p>	<p>Check connection of a USB cable.</p> <p>After you take actions such as turning on the power and connecting the cable, press [Retry].</p>	<p>☞ "Start VPanel" (p. 11)</p> <p>☞ "VPanel Does Not Recognize the Machine" (p. 126)</p>
<p>The modeling machine is not responding.</p> <p>Make sure that the connection cable is connected securely and the machine is switched on.</p>	<p>Check connection of a USB cable.</p> <p>After you take actions such as turning on the power and connecting the cable, press [Retry].</p>	<p>☞ "Operations Are Ignored" (p. 127)</p>
<p>The SRM-20 has performed an emergency stop.</p> <ul style="list-style-type: none"> - X-Limit switch not found. - Y-Limit switch not found. - Z-Limit switch not found. - The NVRAM could not be accessed. 	<p>Switch the machine's power off, then back on again.</p> <p>If the symptom persists, a malfunction may have occurred.</p> <p>Switch off the machine's power and contact your authorized Roland DG Corporation dealer where you purchase the machine.</p>	
<p>The SRM-20 is paused.</p> <ul style="list-style-type: none"> - Cover opened during operation. 	<p>Operation cannot be continued.</p> <p>In order to resume cutting, please close a front cover and click [RESUME].</p> <p>Click [STOP], when you stop cutting.</p>	<p>☞ "Pausing / Resuming" (p. 104)</p> <p>☞ "Cancel the Cutting" (p. 105)</p>
<p>The SRM-20 is paused.</p> <ul style="list-style-type: none"> - Command Error 	<p>You can ignore this and continue with cutting, but doing so is very likely to result in unintended operation, so we strongly recommend you stop cutting.</p> <p>If command does not match the machine's command set, select correct command set.</p>	<p>☞ "STEP 3 : Confirm the Command Set" (p. 83)</p> <p>☞ "Cancel the Cutting" (p. 105)</p>

Message	Responding	Page
<p>The spindle rotation is stopped.</p> <ul style="list-style-type: none"> - The spindle motor experienced an overcurrent. - The spindle motor experienced an excessive load or it is not mounted. 	<p>Turn off power of the machine.</p> <p>The cutting may have exceeded the capacity of the machine. Before restarting, revise the cutting conditions.</p> <p>It is likely that it is time to replace the spindle unit or spindle motor, so check these parts.</p>	<ul style="list-style-type: none"> ☞ “The Spindle Doesn’t Rotate / Spindle Rotation Speed Is Wrong” (p. 128) ☞ “Replacement of the Consumable Parts” (p. 122)
<p>The SRM-20 has performed an emergency stop.</p> <ul style="list-style-type: none"> - The X-Motor experienced an overload. - The Y-Motor experienced an overload. - The Z-Motor experienced an overload. 	<p>Turn off power of the machine.</p> <p>The cutting may have exceeded the capacity of the machine. Before restarting, revise the cutting conditions.</p> <p>If cutting waste has built up and an excess load is being applied to the axis, please clean up the cutting waste.</p>	<ul style="list-style-type: none"> ☞ “Cleaning the X-/Z-Shafts” (p. 119)
<p>"File name" was not found.</p>	<p>Delete the file that produced the error and select the file again.</p>	<ul style="list-style-type: none"> ☞ “Cut Dialog” (p. 17)

Appendix

Specifications	147
External View	147
Main Specifications	151

Specifications

External View

Front

Unit : mm

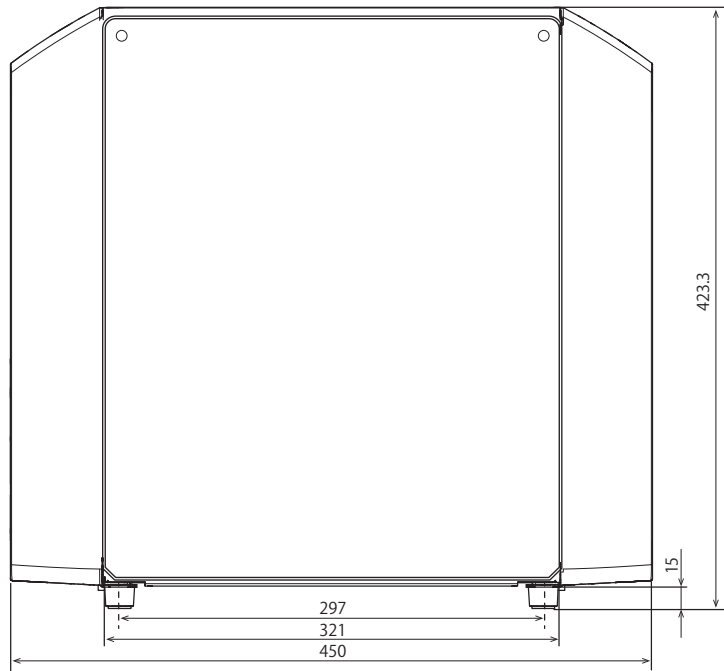

Side

Unit : mm

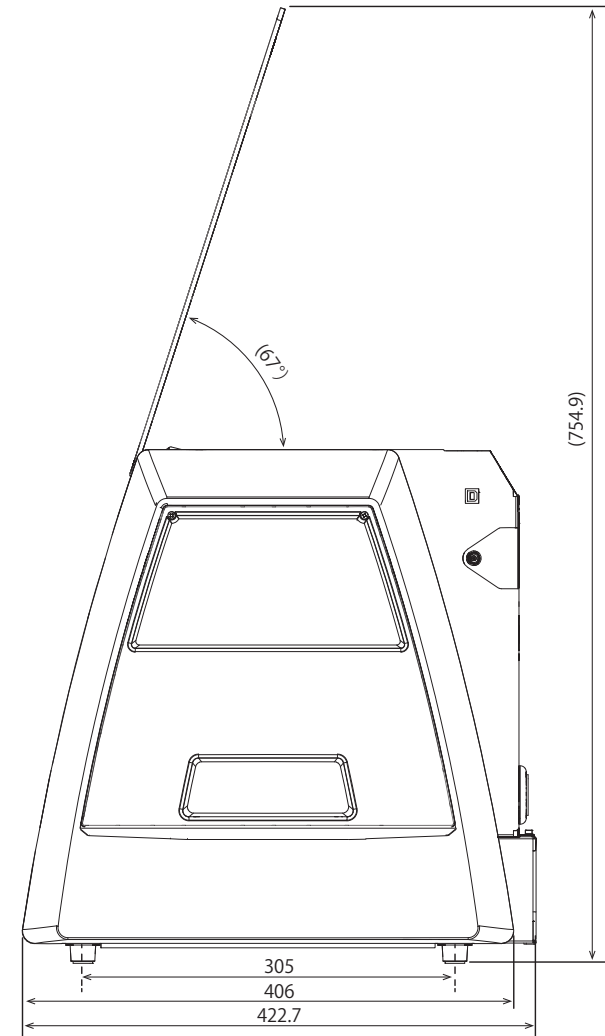

Side Cover

Unit: mm

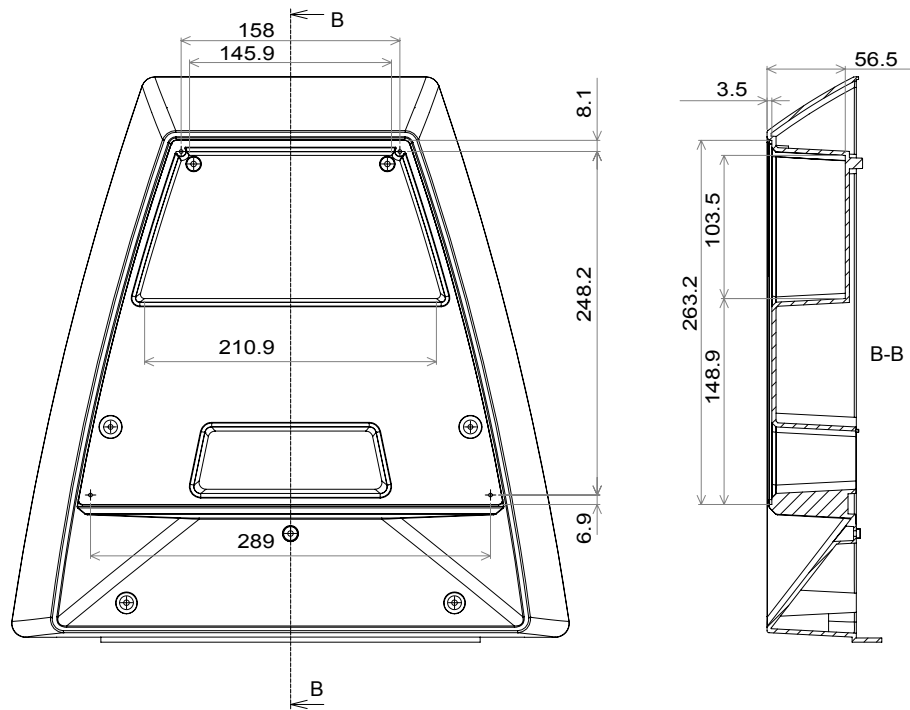

Side Cover Plate

Unit: mm

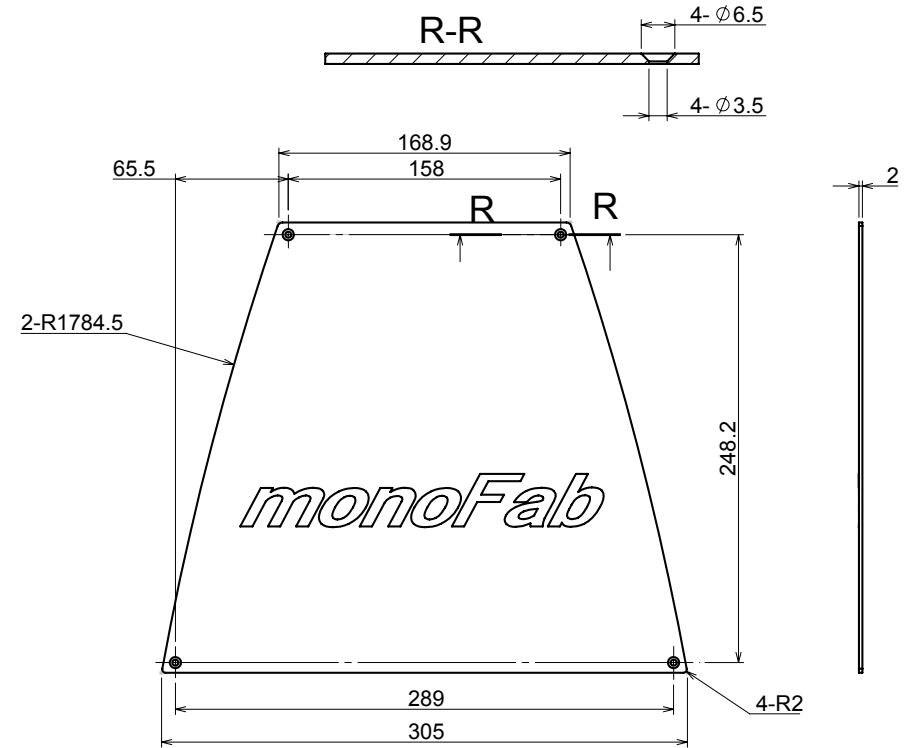

Machine Interior Side Face

Unit: mm

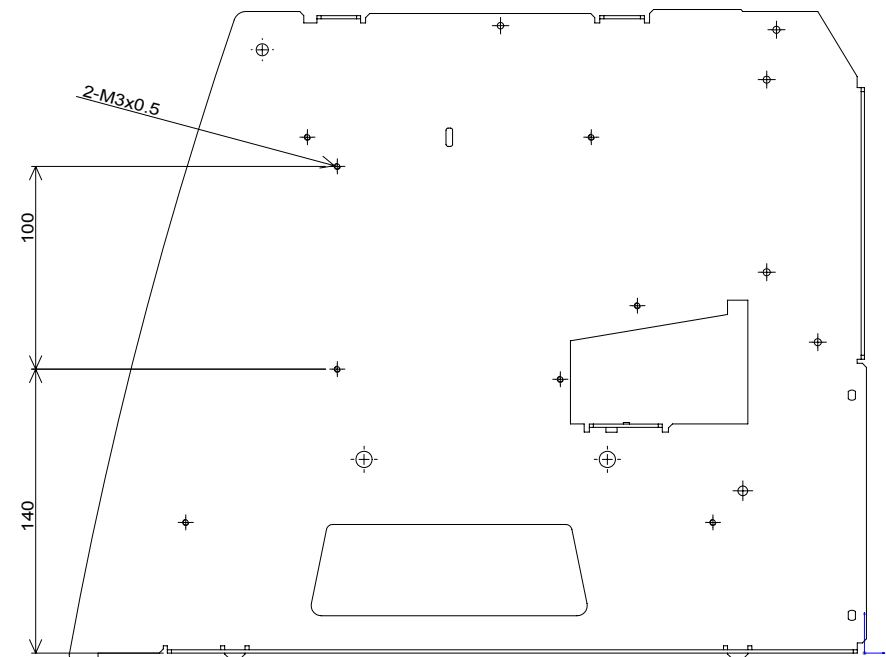
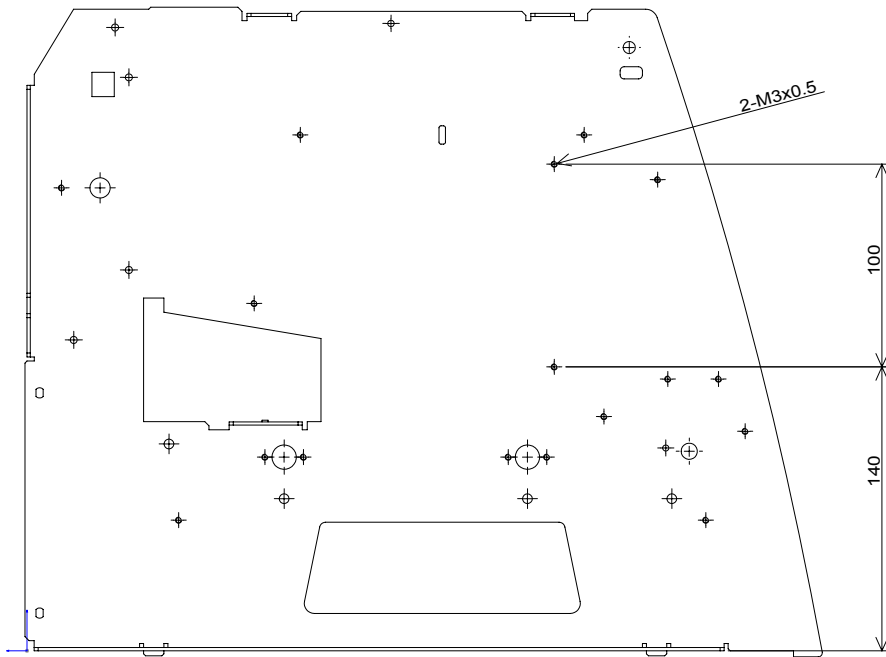

Spindle Head Carriage

Unit: mm

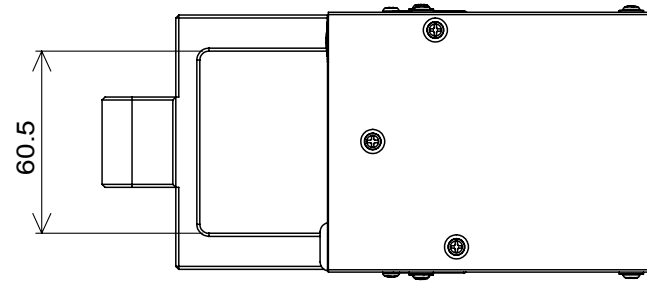
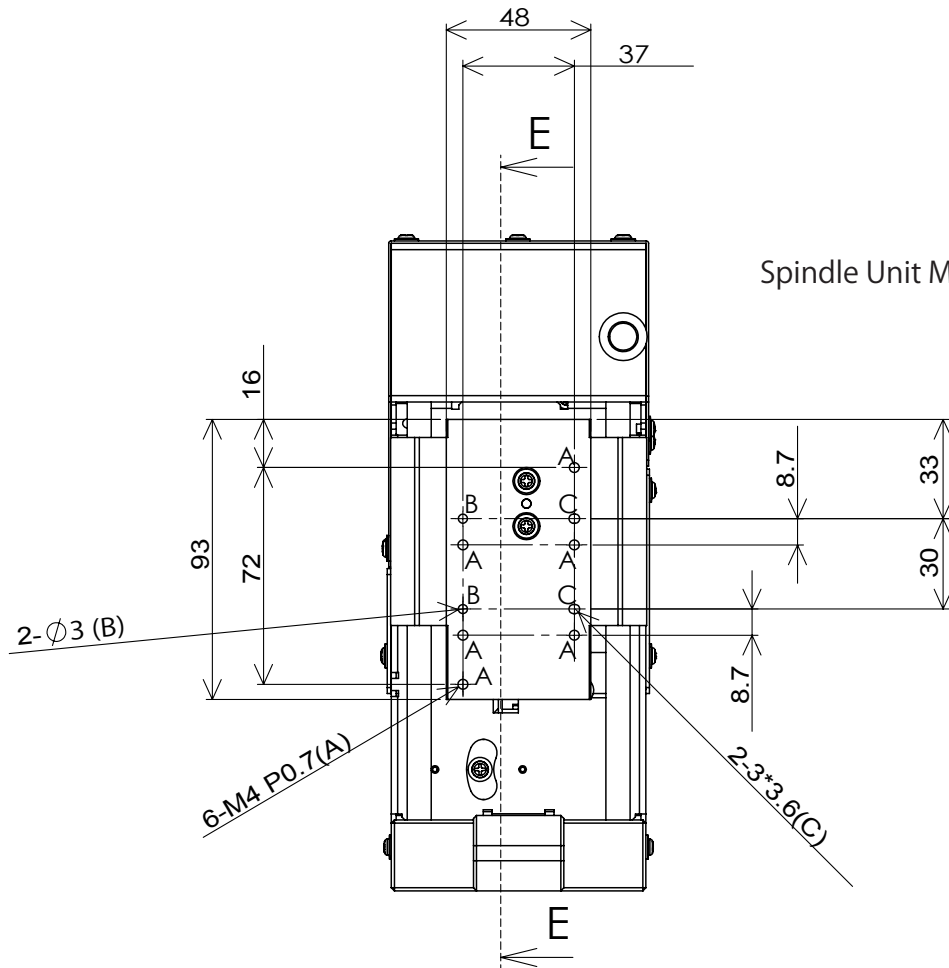

Spindle Unit Mounting Face

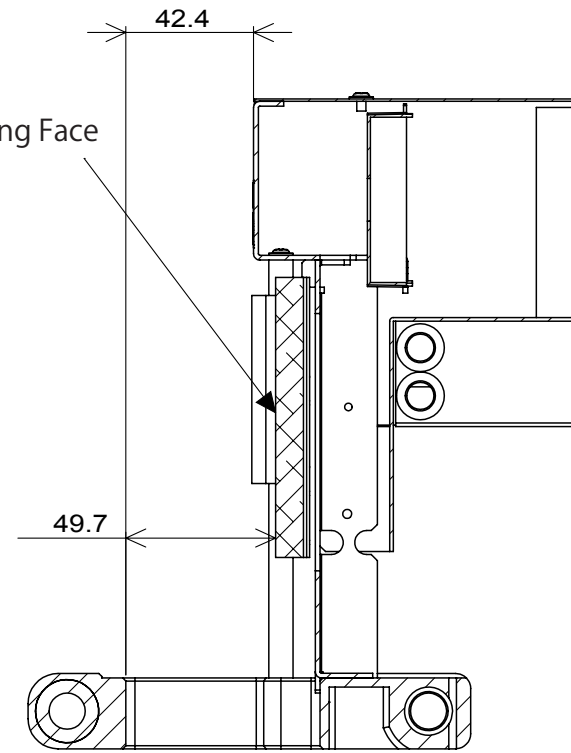

E-E

Main Specifications

		SRM-20
Cutable material		Resins such as chemical wood and modeling wax (metal not supported), substrates for machining
X, Y, and Z operation strokes		203.2 (X) x 152.4 (Y) x 60.5 (Z) mm (8 (X) x 6 (Y) x 2.38 (Z) inches)
Distance from collet tip to table		Maximum 130.75 mm (5.15 inches)
Table size		232.2 (X) x 156.6 (Y) mm (9.14 (X) x 6.17 (Y) inches)
Loadable workpiece weight		2 kg (4.4 lbs)
X-, Y-, and Z-axis drive system		Stepping motor
Operating speed		6 ~ 1800 mm/min (0.24 ~ 70.87 inches/min)
Software resolution		0.01 mm/step (RML-1), 0.001 mm/step (NC code) (0.00039 inches/step (RML-1), 0.000039 inches/step (NC code))
Mechanical resolution		0.000998594 mm/step (0.0000393 inches/step)
Spindle motor		DC motor Type 380
Maximum spindle rotation		7,000 rpm
Cutting tool chuck		Collet method
Interface		USB
Control command sets		RML-1, NC code
Power requirements	Machine	DC 24 V, 2.5 A
	Dedicated AC adapter	AC 100-240 V \pm 10 %, 50/60 Hz
Power consumption		Approx. 55 W
Operating noise	During standby	45 dB (A) or less
	During operation (when not cutting)	65 dB (A) or less
External dimensions		451.0 (W) x 426.6 (D) x 426.2 (H) mm (17.76 (W) x 16.80 (D) x 16.78 (H) inches)
Weight		19.6 kg (43.2 lbs)
Installation Environment		Temperature of 5 to 40°C (41 to 104 °F), 35 to 80% relative humidity (no condensation)
Included items		USB cable, AC adapter, Power cord, Cutting tool, Collet, Set screw, Spanners (7,10 mm / 0.28, 0.39 inches), Hexagonal wrench (size 2, 3 mm /0.08, 0.12 inches), Positioning pins, Double-sided tape, Start-up page information card, Read this first (Booklet)

