

CAMM-1 GS-24

Installation Guide

What you need to read before using the machine

STEP1

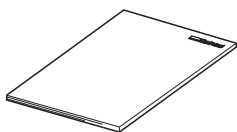

Installation Guide (this document)

This manual contains information on handling precautions, installation instructions, and preparations before use. This manual must be read first.

STEP2

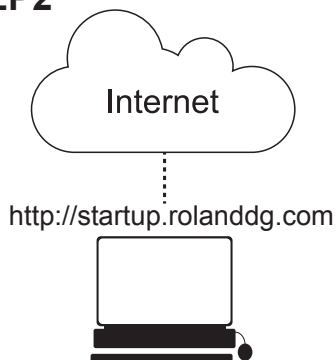

Startup Guide (web page)

This is an online manual that must be read after this guide. It contains instructions about work that must be carried out before using the machine such as downloading and installing software and the User's Manual.

What you need to read when using the machine

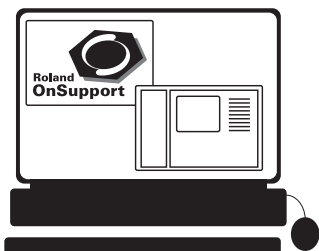

User's Manual (electronic-format manual)

This manual explains the process from setting material to creating output data, output methods, and more. Download the manual from the internet according to the instructions on the aforementioned "Startup Guide (web page)."

Manual for included software "CutStudio"

The manual for the software used to create output data for the machine, "CutStudio," is incorporated in the Help files.

Thank you very much for purchasing this product.

- To ensure correct and safe usage with a full understanding of this product's performance, please be sure to read through this manual completely and store it in a safe location.
- Unauthorized copying or transferral, in whole or in part, of this manual is prohibited.
- The contents of this operation manual and the specifications of this product are subject to change without notice.
- The operation manual and the product have been prepared and tested as much as possible. If you find any misprint or error, please inform us.
- Roland DG Corp. assumes no responsibility for any direct or indirect loss or damage which may occur through use of this product, regardless of any failure to perform on the part of this product.
- Roland DG Corp. assumes no responsibility for any direct or indirect loss or damage which may occur with respect to any article made using this product.

For the USA

FEDERAL COMMUNICATIONS COMMISSION RADIO FREQUENCY INTERFERENCE STATEMENT

NOTE:

This equipment has been tested and found to comply with the limits for a Class A digital device, pursuant to part 15 of the FCC Rules. These limits are designed to provide reasonable protection against harmful interference when the equipment is operated in a commercial environment. This equipment generates, uses, and can radiate radio frequency energy and, if not installed and used in accordance with the instruction manual, may cause harmful interference to radio communications. Operation of this equipment in a residential area is likely to cause harmful interference in which case the user will be required to correct the interference at his own expense.

Unauthorized changes or modification to this system can void the users authority to operate this equipment.

Use only I/O cables that have been designed and manufactured specifically for this device.

For Canada

CAN ICES-3 (A)/NMB-3(A)

For California



WARNING: This product can expose you to chemicals including lead, which is known to the State of California to cause cancer and birth defects or other reproductive harm. For more information go to www.P65Warnings.ca.gov.

For EU Countries

WARNING

This is a Class A product. In a domestic environment this product may cause radio interference in which case the user may be required to take adequate measures.

For EU Countries



Manufacturer:
ROLAND DG CORPORATION
 1-6-4 Shinmiyakoda, Kita-ku, Hamamatsu-shi, Shizuoka-ken, 431-2103 JAPAN

The importer in the EU:
Roland DG Europe Holdings B.V.
 Prof. J.H. Bavincklaan 2, 1183 AT, Amstelveen, The Netherlands

For UK



Manufacturer:
ROLAND DG CORPORATION
 1-6-4 Shinmiyakoda, Kita-ku, Hamamatsu-shi, Shizuoka-ken, 431-2103 JAPAN

The importer in the UK:
Roland DG (U.K.) Ltd.
 Griffin House, Windmill Road, Clevedon Business Park, Clevedon, North Somerset, BS21 6UJ,
 United Kingdom



Contents

Contents	E-1
To Ensure Safe Use	E-2
Pour utiliser en toute sécurité	E-7
1. Installation	E-12
Checking the Included Items	E-12
Deciding On an Installation Site	E-12
Temperature and Humidity	E-12
Installation Space	E-13
Installation Height Position	E-13
Removing the Packing Materials	E-14
Connecting the Power Cable	E-15
2. Preparations Before Use	E-16
Setting the Display Language	E-16
Confirming System Requirements	E-16
Windows	E-16
Mac	E-16
Installing Software and Manual	E-17
Software Versions Supported by Plug-Ins	E-17









To Ensure Safe Use

Improper handling or operation of this machine may result in injury or damage to property. Points which must be observed to prevent such injury or damage are described as follows.

Meaning of WARNING and CAUTION

 WARNING	Used for instructions intended to alert the user to the risk of death or severe injury should the unit be used improperly.
 CAUTION	Used for instructions intended to alert the user to the risk of injury or material damage should the unit be used improperly. * Material damage refers to damage or other adverse effects caused with respect to the home and all its furnishings, as well to domestic animals or pets.

About the Symbols

	The  symbol alerts the user to important instructions or warnings. The specific meaning of the symbol is determined by the design contained within the  symbol. The symbol at left means "danger of electrical shock."
	The  symbol alerts the user to items that must never be carried out (are forbidden). The specific meaning of the symbol is determined by the design contained within the  symbol. The symbol at left means the unit must never be disassembled.
	The  symbol alerts the user to things that must be carried out. The specific meaning of the symbol is determined by the design contained within the  symbol. The symbol at left means the power-cord plug must be unplugged from the outlet.

 **Incorrect operation may cause injury**

 **WARNING**



Before attempting cleaning, maintenance, or attachment or detachment of optional items, disconnect the power cord.

Attempting such operations while the machine is connected to a power source may result in injury or electrical shock.



Keep children away from the machine.

The machine includes areas and components that pose a hazard to children and may result in injury, blindness, choking, or other serious accident.



Never attempt to disassemble, repair, or modify the machine.

Doing so may result in fire, electrical shock, or injury. Entrust repairs to a trained service technician.



Be sure to follow the operation procedures described in this manual. Never allow anyone unfamiliar with the usage or handling of the machine to touch it.

Incorrect usage or handling may lead to an accident.



Never operate the machine while tired or after ingesting alcohol or any medication.

Operation requires unimpaired judgment. Impaired judgment may result in an accident.

 **WARNING**



Conduct operations in a clean, brightly lit location.

Working in a location that is dark or cluttered may lead to an accident, such as becoming caught in the machine as the result of an inadvertent stumble.



Never climb or lean on the machine.

The machine is not made to support a person. Climbing or leaning on the machine may dislodge components and cause a slip or fall, resulting in injury.



Beware of blade.

This machine has an internal blade. To avoid injury, handle the blade with care.



Never attempt operation while wearing a necktie, necklace, or loose clothing. Bind long hair securely.

Such items may become caught in the machine, resulting in injury.



Exercise caution to avoid being pinched or becoming caught.

Inadvertently touching the machine can result in hands being pinched or becoming caught. Take care when operating the machine.



Never attempt to disassemble or modify the AC adapter.

 **This machine is heavy equipment**

 **CAUTION**



Install the machine in a level and stable location.

Installation in an unsuitable location may cause the machine to fall or tip over.

 **CAUTION**



When using a stand with casters, be sure to lock the casters.

If the machine should begin to topple, a major accident may result, including crushing of the appendages or the body.

 Danger of electrical short, electrical shock, or fire

 **WARNING**

 **Connect to an electrical outlet that complies with this machine's ratings (for voltage, frequency, and current).**

Incorrect voltage or insufficient current may cause fire or electrical shock.

 **If sparking, smoke, burning odor, unusual sound, or abnormal operation occurs, immediately unplug the power cord. Never use if any component is damaged.**

Continuing to use the machine may result in fire, electrical shock, or injury. Contact your authorized Roland DG Corp. dealer.

 **Never use out of doors or in any location where exposure to water or high humidity may occur. Never touch with wet hands.**

Doing so may result in fire or electrical shock.

 **Never allow any foreign object to get inside. Never expose to liquid spills.**

Inserting objects such as coins or matches or allowing beverages to be spilled into the ventilation ports may result in fire or electrical shock. If anything gets inside, immediately disconnect the power cord and contact your authorized Roland DG Corp. dealer.

 **Never place any flammable object nearby. Never use a combustible aerosol spray nearby. Never use in any location where gases can accumulate.**

Combustion or explosion may be a danger.

 **Handle the AC adapter, power cord, plug, and electrical outlet correctly and with care. Never use any item that is damaged.**

Using a damaged item may result in fire or electrical shock.

 **WARNING**

 **When using an extension cord or power strip, use one that adequately satisfies the machine's ratings (for voltage, frequency, and current).**

Use of multiple electrical loads on a single electrical outlet or of a lengthy extension cord may cause fire.

 **Position so that the power plug is within immediate reach at all times.**

This is to enable quick disconnection of the power plug in the event of an emergency. Install the machine next to an electrical outlet. Also, provide enough empty space to allow immediate access to the electrical outlet.

 **For accessories (optional and consumable items, power cord, and the like), use only genuine items compatible with this machine.**

Incompatible items may lead to an accident.

 **Never use the machine for any purpose for which it is not intended, or use the machine in an undue manner that exceeds its capacity.**

Doing so may result in injury or fire.

 **Do not use the supplied power cord and AC adapter for other products.**

 **When not using the machine for an extended period, unplug the power cord.**

This can prevent accidents due to current leakage or unintended operation.

 **Only use the dedicated AC adapter.**

Failure to do so may result in fire or electrical shock.

 Important notes about the power cord, plug, and electrical outlet

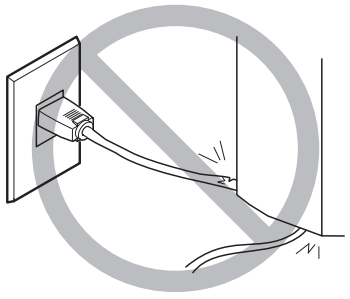

Never place any object on top or subject to damage.



Never allow to get wet.

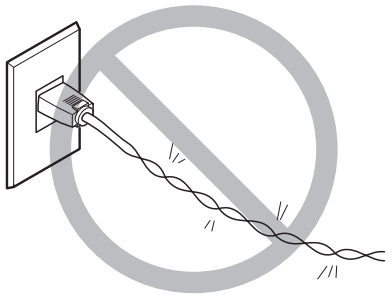

Never bend or twist with undue force.

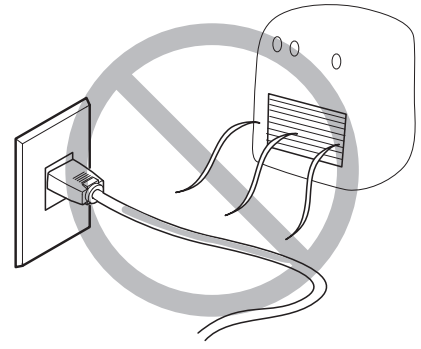

Never subject to heat.

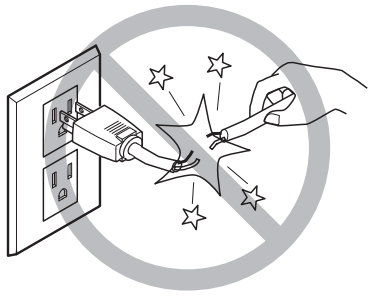

Never pull with undue force.

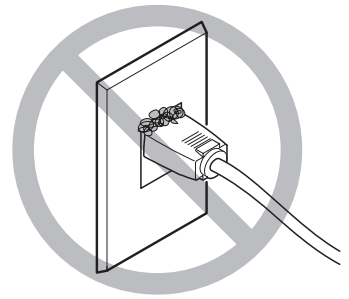

Dust may cause fire.

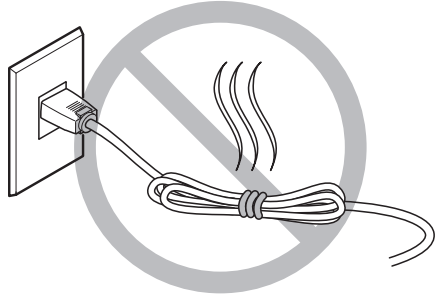

Never bundle, bind, or roll up.

English

To Ensure Safe Use

Warning label

A warning label is affixed to the machine to make areas of danger immediately clear. The meaning of this label is indicated below. Be sure to heed this warning. Also, never remove the label or allow it to become obscured.

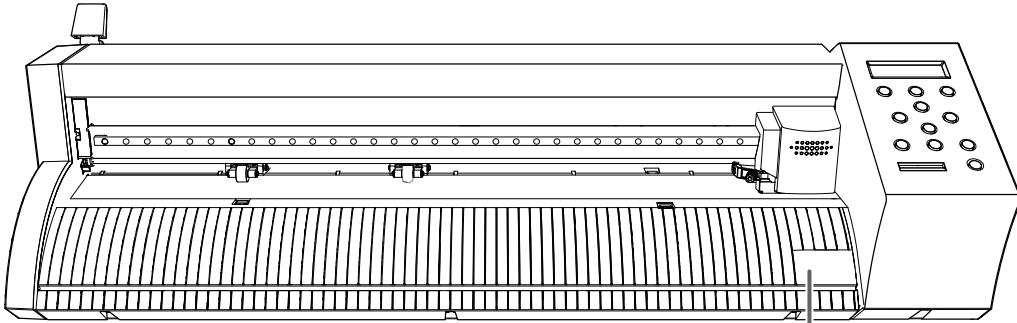



Beware of moving carriage
The cutting carriage is dangerous because it moves at high speed. Do not put hands near it.







Pour utiliser en toute sécurité

La manipulation ou l'utilisation inadéquates de cet appareil peuvent causer des blessures ou des dommages matériels. Les précautions à prendre pour prévenir les blessures ou les dommages sont décrites ci-dessous.

Avis sur les avertissements

 ATTENTION	Utilisé pour avertir l'utilisateur d'un risque de décès ou de blessure grave en cas de mauvaise utilisation de l'appareil.
 PRUDENCE	Utilisé pour avertir l'utilisateur d'un risque de blessure ou de dommage matériel en cas de mauvaise utilisation de l'appareil. * Par dommage matériel, il est entendu dommage ou tout autre effet indésirable sur la maison, tous les meubles et même les animaux domestiques.

À propos des symboles

	Le symbole  attire l'attention de l'utilisateur sur les instructions importantes ou les avertissements. Le sens précis du symbole est déterminé par le dessin à l'intérieur du triangle. Le symbole à gauche signifie "danger d'électrocution".
	Le symbole  avertit l'utilisateur de ce qu'il ne doit pas faire, ce qui est interdit. La chose spécifique à ne pas faire est indiquée par le dessin à l'intérieur du cercle. Le symbole à gauche signifie que l'appareil ne doit jamais être démonté.
	Le symbole  prévient l'utilisateur sur ce qu'il doit faire. La chose spécifique à faire est indiquée par le dessin à l'intérieur du cercle. Le symbole à gauche signifie que le fil électrique doit être débranché de la prise.



L'utilisation incorrecte peut causer des blessures



ATTENTION



Débrancher le câble d'alimentation avant de procéder au nettoyage ou à l'entretien de l'appareil, et avant d'y fixer ou d'en retirer des accessoires en option.

Tenter ces opérations pendant que l'appareil est branché à une source d'alimentation peut causer des blessures ou un choc électrique.



Garder les enfants loin de l'appareil.

L'appareil comporte des zones et des composants qui présentent un danger pour les enfants et qui pourraient causer des blessures, la cécité, la suffocation ou d'autres accidents graves.



Ne jamais tenter de démonter, de réparer ou de modifier l'appareil.

Le non-respect de cette consigne risque de provoquer un incendie, un choc électrique ou des blessures. Confier les réparations à un technicien ayant la formation requise.



S'assurer de suivre les procédures d'utilisation décrites dans le manuel. Ne jamais permettre à quiconque ne connaît pas le fonctionnement ou la manutention de l'appareil de le toucher.

L'utilisation ou la manutention incorrectes peuvent causer un accident.



Ne jamais faire fonctionner l'appareil après avoir consommé de l'alcool ou des médicaments, ou dans un état de fatigue.

L'utilisation de l'appareil exige un jugement sans faille. L'utilisation avec les facultés affaiblies pourrait entraîner un accident.



ATTENTION



Utiliser l'appareil dans un endroit propre et bien éclairé.

Travailler dans un endroit sombre ou encombré peut causer un accident; l'utilisateur risque, par exemple, de trébucher malencontreusement et d'être coincé par une partie de l'appareil.



Ne jamais grimper ni s'appuyer sur la machine.

La machine n'est pas conçue pour supporter le poids d'une personne. Grimper ou s'appuyer sur la machine peut déplacer des éléments et causer un faux pas ou une chute, ce qui causerait des blessures.



Attention à la lame.

Cet appareil contient une lame interne. Pour éviter toute blessure, manipuler cette lame avec précaution.



Ne jamais faire fonctionner l'appareil si on porte une cravate, un collier ou des vêtements amples. Bien attacher les cheveux longs.

Ces vêtements ou ces objets peuvent être coincés dans l'appareil, ce qui causerait des blessures.



Faire preuve de prudence pour éviter l'écrasement ou le coincement.

La main ou les doigts peuvent être écrasés ou coincés s'ils entrent en contact avec certaines surfaces par inadvertance. Faire preuve de prudence pendant l'utilisation de l'appareil.



Ne jamais tenter de démonter, ni de modifier l'adaptateur CA.



Cette machine est très lourde



PRUDENCE



Installer la machine à un emplacement plat et stable.

Tout emplacement mal approprié est susceptible de provoquer la chute ou le renversement de la machine.



PRUDENCE



S'assurer de verrouiller les roulettes de la base.

Si l'appareil devait commencer à basculer, il s'ensuivrait un accident grave, par exemple l'écrasement de membres ou du corps.

 Risque de décharge ou de choc électrique, d'électrocution ou d'incendie

 **ATTENTION**



Brancher à une prise électrique conforme aux caractéristiques de cet appareil (tension, fréquence et courant).

Une tension incorrecte ou un courant insuffisant peuvent causer un incendie ou un choc électrique.



S'il se produit des étincelles, de la fumée, une odeur de brûlé, un bruit inhabituel ou un fonctionnement anormal, débrancher immédiatement le câble d'alimentation. Ne jamais utiliser si un composant est endommagé.

Continuer à utiliser l'appareil peut causer un incendie, un choc électrique ou des blessures. Communiquer avec le représentant Roland DG Corp. Autorisé.



Ne jamais utiliser à l'extérieur ni à un endroit où l'appareil risque d'être exposé à de l'eau ou à une humidité élevée. Ne jamais toucher l'appareil avec des mains mouillées.

Le non-respect de cette consigne risque de provoquer un incendie ou un choc électrique.



Ne jamais insérer d'objet étranger dans l'appareil. Ne jamais exposer l'appareil aux déversements de liquides.

L'insertion d'objets comme des pièces de monnaie ou des allumettes, ou le déversement de liquides dans les orifices de ventilation peuvent causer un incendie ou un choc électrique. Si un objet ou du liquide s'infiltré dans l'appareil, débrancher immédiatement le câble d'alimentation et communiquer avec le représentant Roland DG Corp. autorisé.



Ne jamais placer d'objet inflammable à proximité de l'appareil. Ne jamais utiliser de produit inflammable en aérosol à proximité de l'appareil. Ne jamais utiliser l'appareil dans un endroit où des gaz peuvent s'accumuler.

Une combustion ou une explosion pourraient se produire.



Manipuler l'adaptateur CA, le câble d'alimentation, la fiche et la prise électrique correctement et avec précaution. Ne jamais utiliser de matériel endommagé.

Ne jamais utiliser un article endommagé, car cela pourrait causer un incendie ou un choc électrique.

 **ATTENTION**



Si une rallonge ou une bande d'alimentation électrique sont utilisées, s'assurer qu'elles correspondent aux caractéristiques de l'appareil (tension, fréquence et courant).

L'utilisation de plusieurs charges électriques sur une prise unique ou une longue rallonge peut causer un incendie.



Placer l'appareil de façon à ce que la fiche soit facile d'accès en tout temps.

Ainsi, l'appareil pourra être débranché rapidement en cas d'urgence. Installer l'appareil près d'une prise électrique. En outre, prévoir suffisamment d'espace pour que la prise électrique soit facile d'accès.



Utiliser uniquement des accessoires d'origine (accessoires en option, articles consommables, câble d'alimentation et autres articles semblables), compatibles avec l'appareil.

Les articles incompatibles risquent de causer des accidents.



Ne jamais utiliser l'appareil à des fins autres que celles pour lesquelles il est conçu. Ne jamais l'utiliser de manière abusive ou d'une manière qui dépasse sa capacité.

Le non-respect de cette consigne peut causer des blessures ou un incendie.



Ne pas utiliser le cordon électrique, ni l'adaptateur CA fournis, avec d'autres produits.



En cas de non utilisation prolongée de la machine, débrancher le câble d'alimentation.

Cela permet d'empêcher tout accident dû à une fuite de courant ou une action non intentionnelle.



Utiliser exclusivement l'adaptateur CA dédié.

Tout manquement à cette consigne est susceptible de provoquer un incendie ou un choc électrique.



Remarques importantes à propos du câble d'alimentation, de la fiche et de la prise électrique

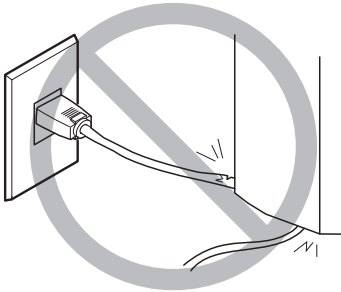

Ne jamais déposer aucun objet sur le câble, sur la fiche ou sur la prise car cela risque de les endommager.

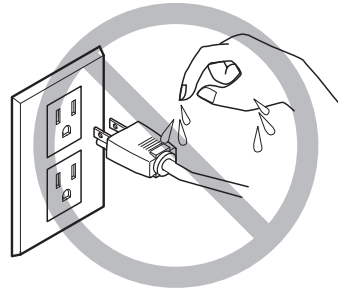

Ne jamais laisser l'eau toucher le câble, la fiche ou la prise.

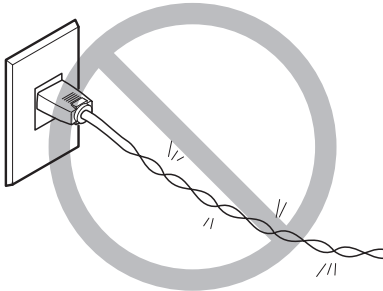

Ne jamais plier ni tordre le câble avec une force excessive.

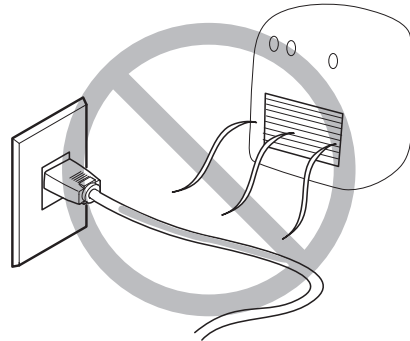

Ne jamais chauffer le câble, la fiche ou la prise.

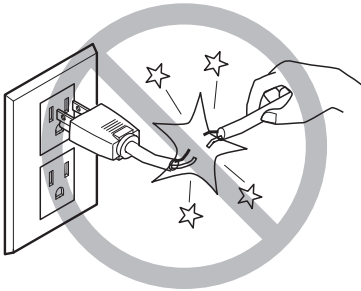

Ne jamais tirer sur le câble ou la fiche avec une force excessive.

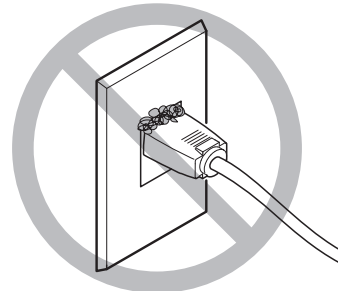

La poussière peut causer un incendie.

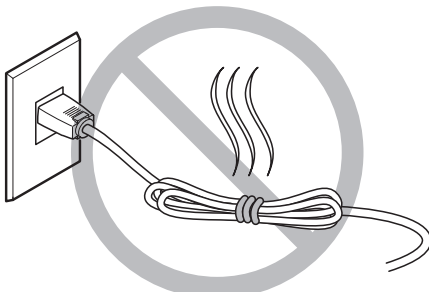

Ne jamais plier ni enrouler le câble.

 **Etiquette d'avertissement**

Une étiquette d'avertissement est apposée sur la machine, afin de signaler clairement les zones dangereuses immédiatement. La signification de cette étiquette est indiquée en dessous. Par conséquent, ne jamais enlever l'étiquette, ni la laisser devenir illisible.

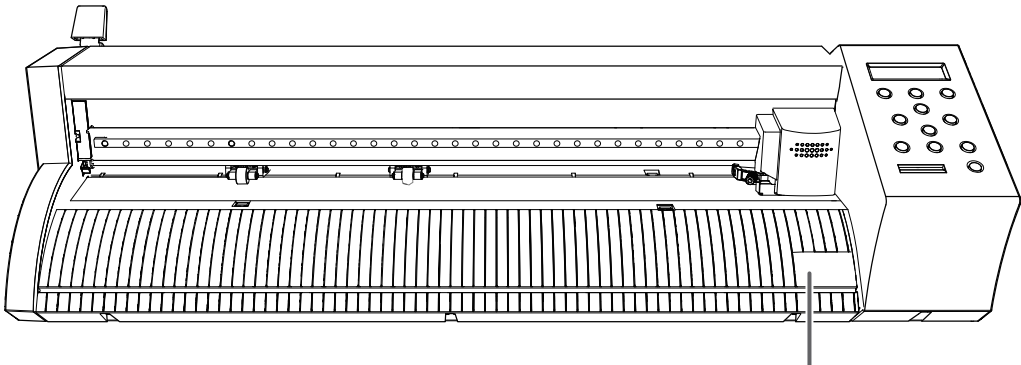





Attention lors du déplacement du chariot
Le chariot de coupe est dangereux car il se déplace très rapidement. Ne pas mettre les mains à proximité de ce dernier.

1. Installation

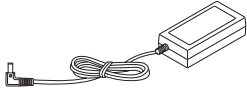
Checking the Included Items

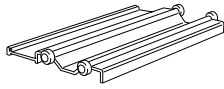
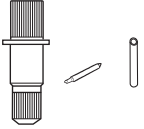
The following items are included with the machine. Make sure they are all present before proceeding.

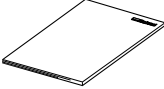
			
AC adapter (1)	Power cord (1)	USB cable (1)	Roller base (1)
			
Blade holder/Blade/Pin (1 each)	Alignment tool (1)	Setup Guide (This document) (1)	

English

Deciding On an Installation Site

Be sure to read "To Ensure Safe Use" (P. E-2) before installing and connecting the machine.

⚠ CAUTION Install the machine in a level and stable location.
Failure to do so may cause the main unit to fall, leading to injury.

Never install the machine in any of the locations below.

Doing so may result in a reduction in quality or malfunction.

- Locations subject to large fluctuations in temperature or humidity
- Locations subject to shaking or vibration
- Locations where the floor is tilted, not level, or unstable
- Dusty locations
- Locations exposed to direct sunlight
- Locations within 1 m of strong indoor lighting
- Locations near air-conditioning or heating equipment
- Locations exposed to water or moving air
- Locations exposed to considerable electrical or magnetic noise, or other forms of electromagnetic energy

Temperature and Humidity

Maintain the specified temperature and humidity even when the machine is not in use. Failure to do so may result in malfunction.

Temperature	Humidity
5 to 40°C (41 to 104°F)	35 to 80% RH (no condensation)

Installation Space

The space shown below is required in order to use the machine.

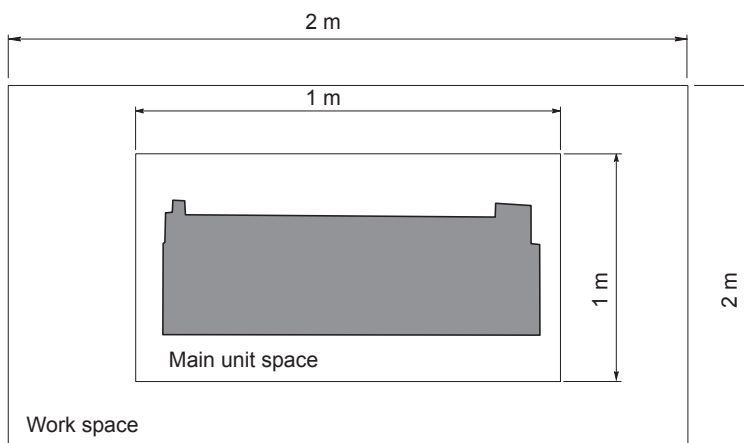

Important

The material moves during cutting. Never place any object at the front or rear of the machine.

Installation Height Position

Install the machine so that it is at least 0.6 m above the work floor.

This machine is designed to be installed on a desktop. Install in a location where the power button and other controls are easily accessible.

⚠ CAUTION When lifting the machine, hold the locations shown in the figure.

⚠ CAUTION Risk of crushing

Take care not to get hands or fingers caught under the machine when installing it on a desktop or mounting it on a stand.

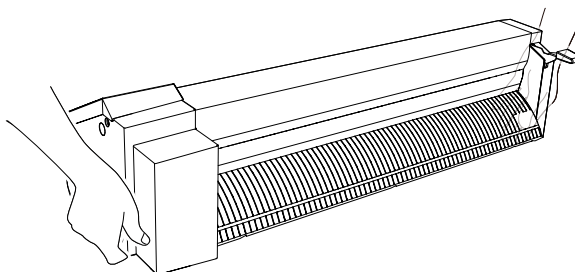

Request: Use a special stand (sold separately)

The special stand is sold separately. For more information, contact your authorized Roland DG Corp. dealer.

Removing the Packing Materials

Packing materials are attached to the machine to protect it from vibration during transportation. When installation is complete, remove these materials.

⚠ WARNING This work must be performed before connecting the power cord.
If the power is turned on while this work is in progress, there is a risk of injury such as hands or fingers getting caught.

- Remove all packing materials. Any that remain may cause faulty operation or breakdown when the power is switched on.
- Store the packing materials carefully, because they are needed again when transporting the machine or the like.

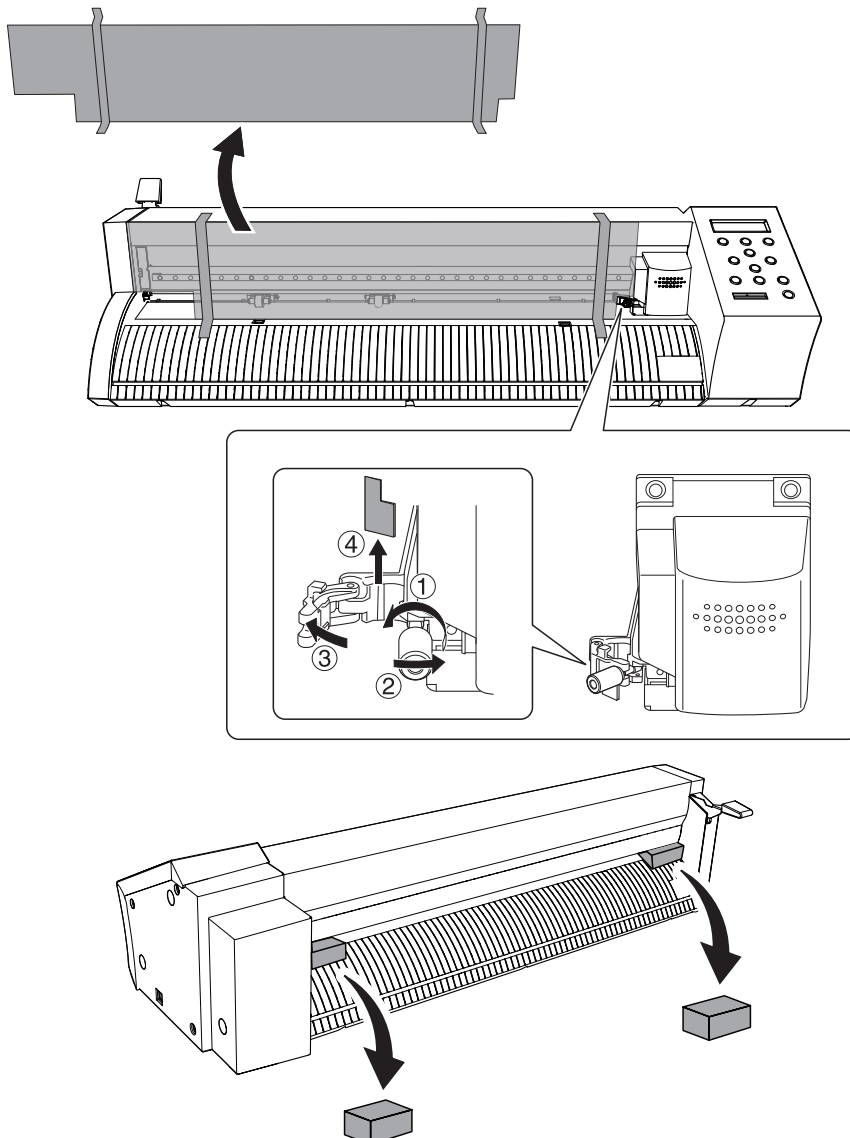

Connecting the Power Cable

- ⚠ WARNING** Connect to an electrical outlet that complies with this machine's ratings (for voltage, frequency, and current).
Incorrect voltage or insufficient current may cause fire or electrical shock.
- ⚠ WARNING** Perform this work with all power switches left switched off.
Failure to do so may result in sudden movement of the machine, which may cause injury.

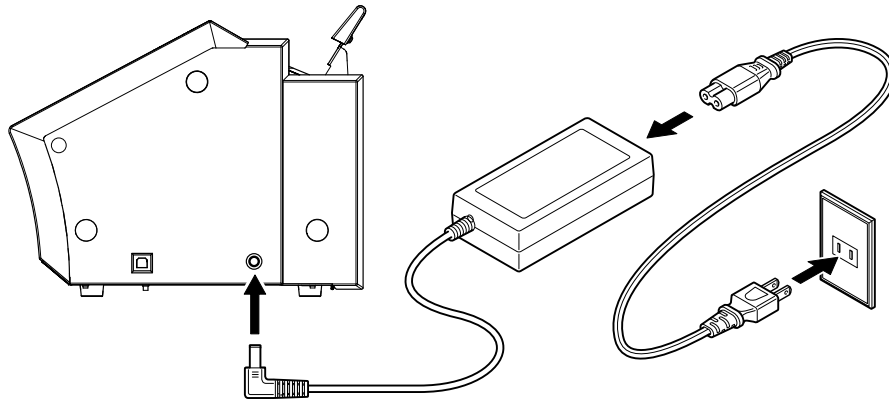

⚠ Important Do not connect to the computer yet.

Use a USB cable to connect the machine to a computer. Do not connect the machine to the computer yet. The machine must be connected to the computer after the Windows driver has been installed. Make sure to connect according to the instructions on the "Startup Guide (web page)" (⇨ P. E-17 "Installing Software and Manual"). If the machine is connected before the driver has been installed, driver installation may fail, and it may not be possible to use the machine.

2. Preparations Before Use

Setting the Display Language

1. Hold down [MENU] and press the power button.

The power is switched on.

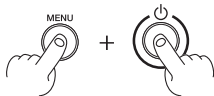

2. Press [▼] and select "ENGLISH."

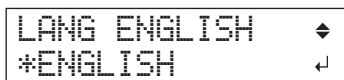

3. Press [ENTER].

The cutting carriage moves to the right edge. Take care not to touch the cutting carriage.

4. Hold down the power button for one second or longer.

The power is switched off.

Confirming System Requirements

The computer requirements for setting up the machine (installing driver, OnSupport, and software) are shown below.

Windows

Operating system (OS)	Windows 8.1/10 (32-bit/64-bit)*
CPU	Intel® Core 2 Duo or later (Core i5 or later recommended)
Memory (RAM)	1 GB or more (2 GB or more recommended)
Video card and display resolution	1280 x 1024 or above recommended
Free hard-disk space required for installation	100 MB or more recommended
Other	<ul style="list-style-type: none">• Internet connectivity and web browser• Internet Explorer version 10 or later recommended

* OnSupport is 32-bit application software and therefore runs on WOW64 (Windows 32-bit on Windows 64-bit) on 64-bit editions of Windows.

Mac

- A Mac with an Intel chipset.
- Adobe Illustrator CS5 or later.

Installing Software and Manual

The software (Windows driver and application software) and manual required to use the machine must be downloaded and installed from the internet

Access the URL below. Download and installation instructions can be found at the relevant URL.

<http://startup.rolanddg.com/>

Software and manual for installation

Software	
Roland OnSupport	This software is required to download and install the application software. Be sure to install it.
Windows driver	This is a Windows-based driver required for sending data from a computer to the machine. Be sure to install it.
Roland CutStudio	This is a Windows-based cutting program that enables you to accomplish high-quality cutting through easy operation. * The manual for this software is incorporated in the Help files.
CutStudio Plug-in for Adobe Illustrator (For Windows)	This is a software plug-in that lets you send data created using Adobe Illustrator directly to CutStudio.
CutStudio Plug-in for CorelDRAW	This is a software plug-in that lets you send data created using CorelDRAW directly to CutStudio.
CutStudio Plug-in for Adobe Illustrator (For Mac)	This is a software plug-in that lets you create cutting data in Adobe Illustrator and perform cutting.
Manual	
GS-24 User's Manual	This manual explains how to operate the machine.

Software Versions Supported by Plug-Ins

CutStudio Plug-in for Illustrator:	Adobe Illustrator CS5 or later
CutStudio Plug-in for CorelDRAW:	CorelDRAW X3 or later

MEMO

A series of horizontal dotted lines for writing, consisting of 25 lines.